



Intel® Solid-State Drive 730 Series

Product Specification

- Capacities: 240GB, 480GB
- Components:
 - Intel® 20nm NAND Flash Memory
 - Multi-Level Cell (MLC)
- Form Factors: 2.5 inch
- Thickness: 7mm
- Weight: Up to 78 grams
- SATA 6Gb/s Bandwidth Performance¹ (Iometer* Queue Depth 32, 128KB³ IO)
 - Sustained Seq Read: Up to 550MB/s²
 - Sustained Seq Write: Up to 470MB/s²
- SATA 6Gb/s Read and Write IOPS¹ (Iometer Queue Depth 32)
 - Random 4KB⁴ Reads: Up to 89,000 IOPS
 - Random 4KB⁴ Writes: Up to 74,000 IOPS
- Latency (average sequential)
 - Read: 50 μs (TYP)
 - Write: 60 μs (TYP)
- Power Management
 - 2.5 inch: 5V or 12V SATA Supply Rail⁴
- Power (5V / 12V)⁵
 - Active: 5.0W / 5.5W
 - Idle: 1.3W / 1.5W
- Temperature
 - Operating: 0° C to 70° C
 - Non-Operating: -55° C to 95° C
- Compatibility
 - Intel® SSD Toolbox with Intel® SSD Optimizer
 - Intel® Data Migration Software
 - Intel® Rapid Storage Technology
 - SATA Revision 3.0
 - ACS-2 (ATA/ATAPI Command Set 2)
 - SSD Enhanced SMART ATA feature set
- Reliability
 - Uncorrectable Bit Error Rate (UBER): < 1 sector/ 10¹⁷ bits reads
 - Mean Time Between Failure (MTBF): 2 Million Hours
 - Shock (operating and non-operating): 1,000 G/0.5 msec
- Endurance
 - Up to 70GB of writes a day⁶
- Vibration
 - Operating: 2.17 GRMS (5-700 Hz)
 - Non-operating: 3.13 GRMS (5-800 Hz)
- Certifications and Declarations:
 - UL*, CE*, C-Tick*, BSMI*, KCC*, Microsoft* WHCK, VCCI*, SATA-IO*
- Product Ecological Compliance
 - RoHS*

Note

1. Performance values vary by capacity, applies both to compressible and incompressible data.
2. MB/s = 1,000,000 bytes/second
3. 4KB = 4,096 bytes; 128KB = 131,072 bytes
4. Defaults to 12V, if both 12V and 5V are present
5. See electrical characteristics section under performance for workload specifics. Based on 480GB SSD
6. Based on JESD218 standard

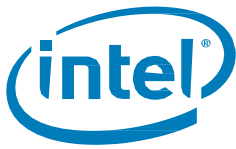

Ordering Information

Contact your local Intel sales representative for ordering information.

INFORMATION IN THIS DOCUMENT IS PROVIDED IN CONNECTION WITH INTEL PRODUCTS. NO LICENSE, EXPRESS OR IMPLIED, BY ESTOPPEL OR OTHERWISE, TO ANY INTELLECTUAL PROPERTY RIGHTS IS GRANTED BY THIS DOCUMENT. EXCEPT AS PROVIDED IN INTEL'S TERMS AND CONDITIONS OF SALE FOR SUCH PRODUCTS, INTEL ASSUMES NO LIABILITY WHATSOEVER AND INTEL DISCLAIMS ANY EXPRESS OR IMPLIED WARRANTY, RELATING TO SALE AND/OR USE OF INTEL PRODUCTS INCLUDING LIABILITY OR WARRANTIES RELATING TO FITNESS FOR A PARTICULAR PURPOSE, MERCHANTABILITY, OR INFRINGEMENT OF ANY PATENT, COPYRIGHT OR OTHER INTELLECTUAL PROPERTY RIGHT.

A "Mission Critical Application" is any application in which failure of the Intel Product could result, directly or indirectly, in personal injury or death. SHOULD YOU PURCHASE OR USE INTEL'S PRODUCTS FOR ANY SUCH MISSION CRITICAL APPLICATION, YOU SHALL INDEMNIFY AND HOLD INTEL AND ITS SUBSIDIARIES, SUBCONTRACTORS AND AFFILIATES, AND THE DIRECTORS, OFFICERS, AND EMPLOYEES OF EACH, HARMLESS AGAINST ALL CLAIMS COSTS, DAMAGES, AND EXPENSES AND REASONABLE ATTORNEYS' FEES ARISING OUT OF, DIRECTLY OR INDIRECTLY, ANY CLAIM OF PRODUCT LIABILITY, PERSONAL INJURY, OR DEATH ARISING IN ANY WAY OUT OF SUCH MISSION CRITICAL APPLICATION, WHETHER OR NOT INTEL OR ITS SUBCONTRACTOR WAS NEGLIGENT IN THE DESIGN, MANUFACTURE, OR WARNING OF THE INTEL PRODUCT OR ANY OF ITS PARTS.

Intel may make changes to specifications and product descriptions at any time, without notice. Designers must not rely on the absence or characteristics of any features or instructions marked "reserved" or "undefined." Intel reserves these for future definition and shall have no responsibility whatsoever for conflicts or incompatibilities arising from future changes to them. The information here is subject to change without notice. Do not finalize a design with this information.

The products described in this document may contain design defects or errors known as errata which may cause the product to deviate from published specifications. Current characterized errata are available on request.

Contact your local Intel sales office or your distributor to obtain the latest specifications and before placing your product order.

Copies of documents which have an order number and are referenced in this document, or other Intel literature, may be obtained by calling 1-800-548-4725, or go to: <http://www.intel.com/design/literature.html>

Low Halogen applies only to brominated and chlorinated flame retardants (BFRs/CFRs) and PVC in the final product. Intel components as well as purchased components on the finished assembly meet JS-709 requirements, and the PCB/substrate meet IEC 61249-2-21 requirements. The replacement of halogenated flame retardants and/or PVC may not be better for the environment.

Software and workloads used in performance tests may have been optimized for performance only on Intel microprocessors. Performance tests, such as SYSmark and MobileMark, are measured using specific computer systems, components, software, operations and functions. Any change to any of those factors may cause the results to vary. You should consult other information and performance tests to assist you in fully evaluating your contemplated purchases, including the performance of that product when combined with other products.

Intel and the Intel logo are trademarks of Intel Corporation in the U.S. and other countries.

*Other names and brands may be claimed as the property of others.

Copyright © 2014 Intel Corporation. All rights reserved.



Contents

Revision History	5
Terms and Acronyms	5
1 Introduction	7
1.1 Reference Documents	8
2 Product Specifications	9
2.1 Capacity	9
2.2 Performance	9
2.3 Electrical Characteristics	10
2.4 Environmental Conditions	11
2.4.1 Temperature, Shock, Vibration	11
2.4.2 Altitude	11
2.5 Product Regulatory Compliance	12
2.6 Reliability	13
2.7 Hot Plug Support	13
3 Mechanical Information	14
4 Pin and Signal Descriptions	15
4.1 Pin Locations	15
4.2 Signal Descriptions	15
4.2.1 Connector Pin Signal Definitions	15
4.2.2 Power Pin Signal Definitions	16
5 Supported Command Sets	17
5.1 ATA General Feature Command Set	17
5.2 Power Management	18
5.3 SMART Command Set	18
5.3.1 SMART Attributes	19
5.3.2 SMART Logs	21
5.4 Device Statistics	22
5.5 SMART Command Transport	22
5.6 Data Set Management Command Set	22
5.7 Host Protected Area Command Set	23
5.8 48-Bit Address Command Set	23
5.9 General Purpose Log Command Set	23
5.10 Native Command Queuing	23
5.11 Software Settings Preservation	23
6 Certifications and Declarations	24
7 Appendix	25

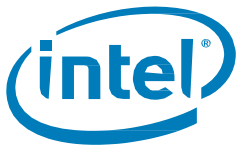

Tables

Table 1:	Terminology	5
Table 2:	Standard References	8
Table 3:	User Addressable Sectors	9
Table 4:	Performance	9
Table 5:	Latency	9
Table 6:	Operating Voltage and Power Consumption	10
Table 7:	Temperature, Shock, Vibration	11
Table 8:	Product Regulatory Compliance Specifications	12
Table 9:	Reliability Specifications	13
Table 10:	Serial ATA Connector Pin Signal Definitions	15
Table 11:	Serial ATA Power Pin Definitions	16
Table 12:	SMART Attributes	19
Table 13:	SMART Attribute Status Flags	21
Table 14:	Device Statistics Log	22
Table 15:	Device Certifications and Declarations	24
Table 16:	Identify Device Returned Sector Data	25

Figures

Figure 3-1:	Dimensions for Full Size 2.5 inch Drives	14
Figure 4-1:	Layout of Signal and Power Segment Pins	15



Revision History

Document Number	Revision Number	Description	Revision Date
329673	001	Initial release	February 2014
329673	002	Page 1, note 3 updated	March 2014

Terms and Acronyms

Table 1: Terminology

Term	Description
ATA	Advanced Technology Attachment
DAS	Device Activity Signal
DMA	Direct Memory Access
EXT	Extended
FPDMA	First Party Direct Memory Access
GB	Gigabyte (1,000,000,000 bytes) Note: The total usable capacity of the SSD may be less than the total physical capacity because a small portion of the capacity is used for NAND flash management and maintenance purposes.
Gb	Gigabit (1,000,000,000 bits)
HDD	Hard Disk Drive
I/O	Input/Output
IOPS	Input/Output Operations Per Second
KB	Kilobyte (1,024 bytes)
LBA	Logical Block Address
MB	Megabyte (1,000,000 bytes)
MLC	Multi-level Cell
MTBF	Mean Time Between Failures
NCQ	Native Command Queuing
NOP	No Operation
PIO	Programmed Input/Output
RDT	Reliability Demonstration Test
RMS	Root Mean Squared
SATA	Serial Advanced Technology Attachment
SMART	Self-Monitoring, Analysis and Reporting Technology
SSD	Solid-State Drive
TYP	Typical

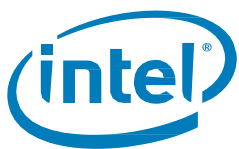

Term	Description
UBER	Uncorrectable Bit Error Rate

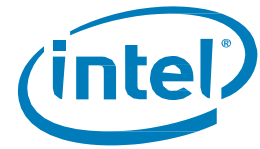

1 Introduction

This document describes the specifications and capabilities of the Intel® Solid-State Drive 730 Series (Intel SSD 730 Series).

The Intel SSD 730 Series is a standard 2.5 inch form factor solid-state drive delivering leading performance for Serial Advanced Technology Attachment (SATA)-based desktop and workstation computers in 240GB and 480GB capacities.

The Intel SSD 730 Series is a higher performance client SSD utilizing high-endurance components engineered for PC enthusiast and workstation systems with demanding storage workload requirements. Intel SSD 730 Series is Intel's first SSD engineered with factory overclocked SSD controller and NAND bus speeds. By increasing the controller clock speed from 400MHz to 600MHz, increasing NAND bus speeds from 83MHz to 100MHz and optimizing firmware for client platforms, Intel has developed its highest performance client SSD for uncompressible workloads. This allows 550 MB/s sequential read and 450 MB/s sequential write performance.

Intel SSD 730 Series component and NAND management provide consistent performance for single drive and RAID configurations across all data types. This same Intel design delivers higher endurance far exceeding the requirements of client usages with up to 70GB writes per day.

These features, offered with Intel's 5 year warranty makes the Intel SSD 730 Series a remarkably compelling PC client storage solution for PC enthusiast and workstation platforms.

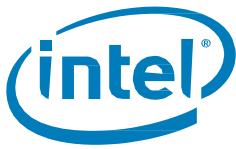

1.1 Reference Documents

Table 2: Standard References

Date or Rev. #	Title	Location
May 2005	SFF-8201, 2.5-inch drive form factor	http://www.sffcommittee.org/
May 2006	SFF-8223, 2.5-inch Drive w/Serial Attachment Connector	http://www.sffcommittee.org/
Sept 2008	IEC* 55022 Information Technology Equipment — Radio disturbance Characteristics— Limits and methods of measurement CISPR22:2008 (Modified)	http://www.iec.ch/
Dec 2008	VCCI	http://www.vcci.jp/vcci_e/
June 2009	RoHS	http://qdms.intel.com/ Click <i>Search MDDS Database</i> and search for material description datasheet
June 2009	Serial ATA Revision 3.0	http://www.sata-io.org/
August 2009	ACS-2 Specification	http://www.t13.org/
August 2010	IEC 55024 Information Technology Equipment — Immunity characteristics— Limits and methods of measurement CISPR24:2010	http://www.iec.ch/



2 Product Specifications

2.1 Capacity

Table 3: User Addressable Sectors

Intel® SSD 730 Series	Unformatted Capacity (Total User Addressable Sectors in LBA mode)
240GB	468,862,128
480GB	937,703,088

2.2 Performance

Table 4: Performance¹

Specification	Unit	Intel® SSD 730 Series	
		240GB	480GB
Random 4KB Read (up to) ²	IOPS	86,000	89,000
Random 4KB Write (up to) ²	IOPS	56,000	74,000
Sequential 128KB Read (SATA 6 Gb/s) ³	MB/s ⁴	550	550
Sequential 128KB Write (SATA 6 Gb/s) ³	MB/s ⁴	270	470

Note:

1. Performance measured using Iometer* with Queue Depth 32. Measurements are performed on 8 GB of Logical Block Address (LBA) range on a full SSD
2. 4KB = 4096 bytes
3. 128KB = 131,072 bytes
4. MB/s = 1,000,000 bytes/second

Table 5: Latency

Specification	Intel® SSD 730 Series	
	240GB	480GB
Read ¹	50 μs (TYP)	
Write ¹	60 μs (TYP)	
Power On To Ready ²	2 seconds	

Note:

1. Based on sequential 4KB using Iometer* with Queue Depth 1 workload with Write Cache enabled
2. Power On To Ready time assumes proper shutdown

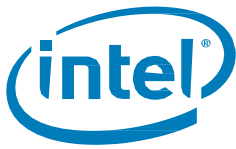

2.3 Electrical Characteristics¹

Table 6: Operating Voltage and Power Consumption

Electrical Characteristics	Values (5V / 12V)	
	240GB	480GB
Operating Voltage for 5V (±5%) Min. Max. Rise Time (Max./Min.) Fall Time (Max./Min.) Noise Tolerance Min. Off Time ²	4.75V 5.25V 1 sec / 1 ms 1 ms 50 mV pp (100 KHz – 20 MHz) 500 ms	
Operating Voltage for 12V (±10%) Min. Max. Rise Time (Max./Min.) Fall Time (Max./Min.) Noise Tolerance Min. Off Time ²	10.8V 13.2V 1 sec / 1 ms 1 ms 100 mV pp (100 KHz – 20 MHz) 500 ms	
Idle	1.2W / 1.5W	1.3W / 1.5W
Active (Thermal) Power ³	3.4W / 3.8W	5.0W / 5.5W
Regulator Power ⁴	3.8W / 4.2W	5.8W / 6.4W

Notes:

1. All electrical characterization values reflect SSDs with 5V / 12V supply.
2. Minimum time from power down of drive ($V_{cc} < 100$ mV) to when it can be powered up.
3. Power measured during 128KB sequential writes with Queue Depth 32 workload using 100 ms sample period. This represents power that would be thermal load on system during heavy workloads.
4. Power measured during 128KB sequential writes with Queue Depth 32 workload using 500 μ s sample period. This represents the amount of power that system power supply needs to regulate for proper device operation.

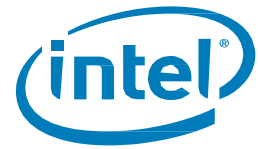

2.4 Environmental Conditions

2.4.1 Temperature, Shock, Vibration

Table 7: Temperature, Shock, Vibration

Electrical Characteristics	Range
Case Temperature Operating Non-operating ¹	0° C - 70° C -55° C - 95° C
Temperature Gradient ² Operating Non-operating	30 (TYP)° C/hr 30 (TYP)° C/hr
Humidity Operating Non-operating	5 – 95% 5 – 95%
Shock and Vibration	Range
Shock ³ Operating Non-operating	1,000G (Max) at 0.5 msec 1,000G (Max) at 0.5 msec
Vibration ⁴ Operating Non-operating	2.17 GRMS (5-700 Hz) Max 3.13 GRMS (5-800 Hz) Max

Note:

1. Please contact your Intel representative for details on the non-operating temperature range.
2. Temperature gradient measured without condensation.
3. Shock specifications assume the SSD is mounted securely with the input vibration applied to the drive-mounting screws. Stimulus may be applied in the X, Y or Z axis. Shock specification is measured using peak acceleration and pulse width value.
4. Vibration specifications assume the SSD is mounted securely with the input vibration applied to the drive-mounting screws. Stimulus may be applied in the X, Y or Z axis. Vibration specification is measured using G Root Mean Squared (GRMS) value.

2.4.2 Altitude

The drive is not sensitive to changes in atmospheric pressure because it has no moving parts. Drive was tested under non-operational conditions to pressures representative of -1 K and +40 K feet.

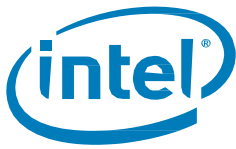

2.5 Product Regulatory Compliance

The Intel® SSD 730 Series meets or exceeds the regulatory or certification requirements in Table 8.

Table 8: Product Regulatory Compliance Specifications

Title	Description	Region For Which Conformity Declared
TITLE 47-Telecommunications CHAPTER 1 — FEDERAL COMMUNICATIONS COMMISSION PART 15 — RADIO FREQUENCY DEVICES ICES*-003, Issue 4 Interference-Causing Equipment Standard Digital Apparatus	FCC Part 15B Class B CA/CSA-CEI/IEC CISPR 22-10 (Ref. CISPR 22:2008).	USA Canada
IEC* 55024 Information Technology Equipment — Immunity characteristics — Limits and methods of measurement CISPR24:2010	EN-55024: 2010 and its amendments	European Union
IEC* 55022 Information Technology Equipment — Radio disturbance Characteristics — Limits and methods of measurement CISPR24:2008 (Modified)	EN-55022: 2010 and its amendments	European Union
EN-60950-1 2 nd Edition	Information Technology Equipment — Safety — Part 1: General Requirements	USA/Canada
UL/CSA EN-60950-1 2 nd Edition	Information Technology Equipment — Safety — Part 1: General Requirements	USA/Canada

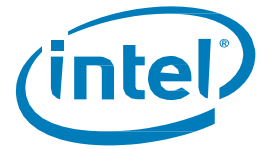

2.6 Reliability

The Intel® SSD 730 Series meets or exceeds SSD endurance and data retention requirements as specified in the JESD218* specification.

Table 9: Reliability Specifications

Parameter	Value
Uncorrectable Bit Error Rate (UBER) Uncorrectable bit error rate will not exceed one sector in the specified number of bits read. In the unlikely event of a non-recoverable read error, the SSD will report it as a read failure to the host; the sector in error is considered corrupt and is not returned to the host.	< 1 sector per 10^{17} bits read
Mean Time Between Failures (MTBF) Mean Time Between Failures is estimated based on Telcordia* methodology and demonstrated through Reliability Demonstration Test (RDT).	≥ 2.0 million hours
Minimum Useful Life/Endurance Rating The SSD will have a minimum useful life based on a typical client workload assuming up to 50GB of host writes per day for the 240GB SSD and 70GB of host writes per day for the 480GB SSD.	5 years
Insertion Cycles Maximum insertion/removal cycles on 2.5 inch port	250 insertion/removal cycles

NOTE:

- 1.Refer to JESD218 for standards information Based on JESD219 workload.

2.7 Hot Plug Support

Hot Plug insertion and removal is supported in the presence of a proper connector and appropriate operating system, as described in the SATA* 3.0 specification.

This product supports asynchronous signal recovery and issues an unsolicited COMINIT when first mated with a powered connector to enable reliable detection by a host system without hardware device detection.

3 Mechanical Information

Figure 3-1 shows the mechanical information for the 2.5 inch Intel® SSD 730 Series. All dimensions are in millimeters.

Figure 3-1: Dimensions for Full Size 2.5 inch Drives

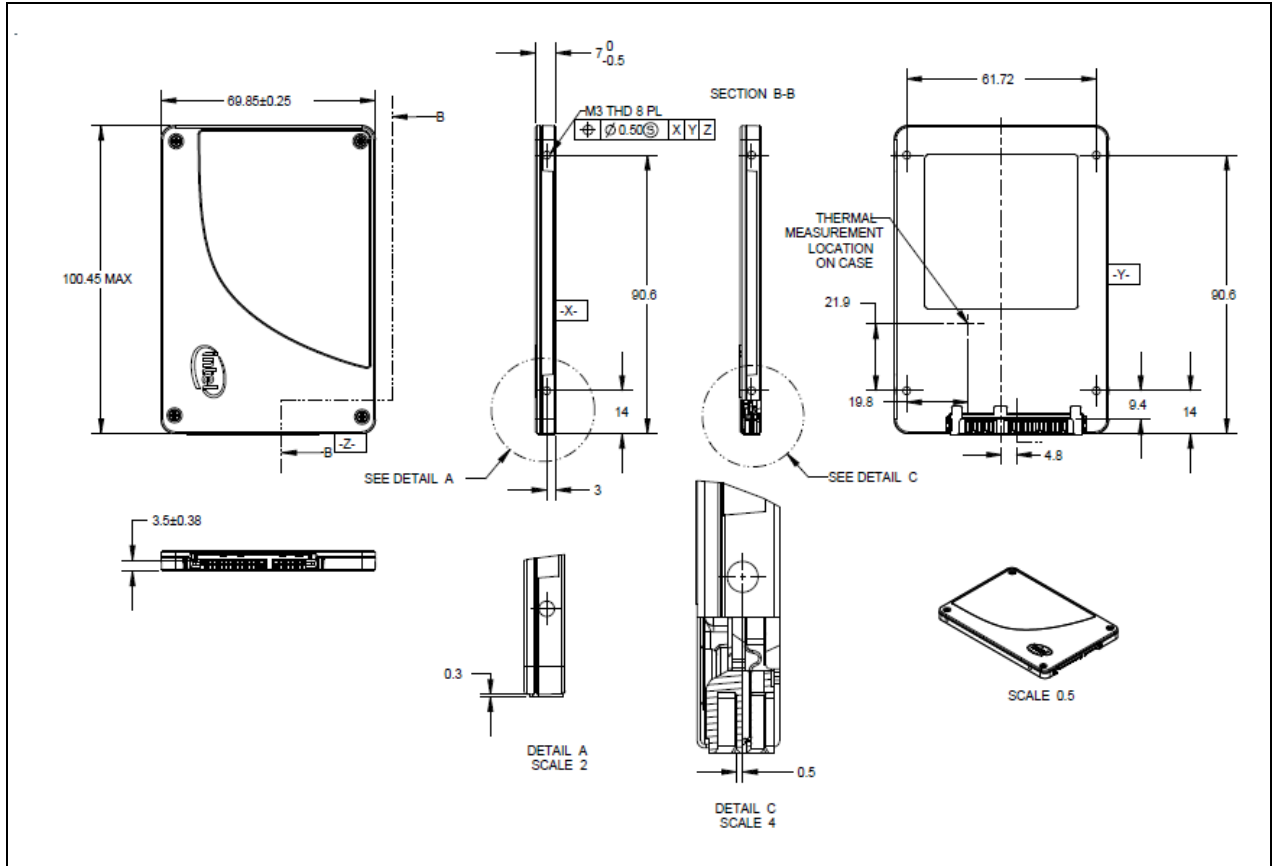

4 Pin and Signal Descriptions

4.1 Pin Locations

Figure 4-1: Layout of Signal and Power Segment Pins

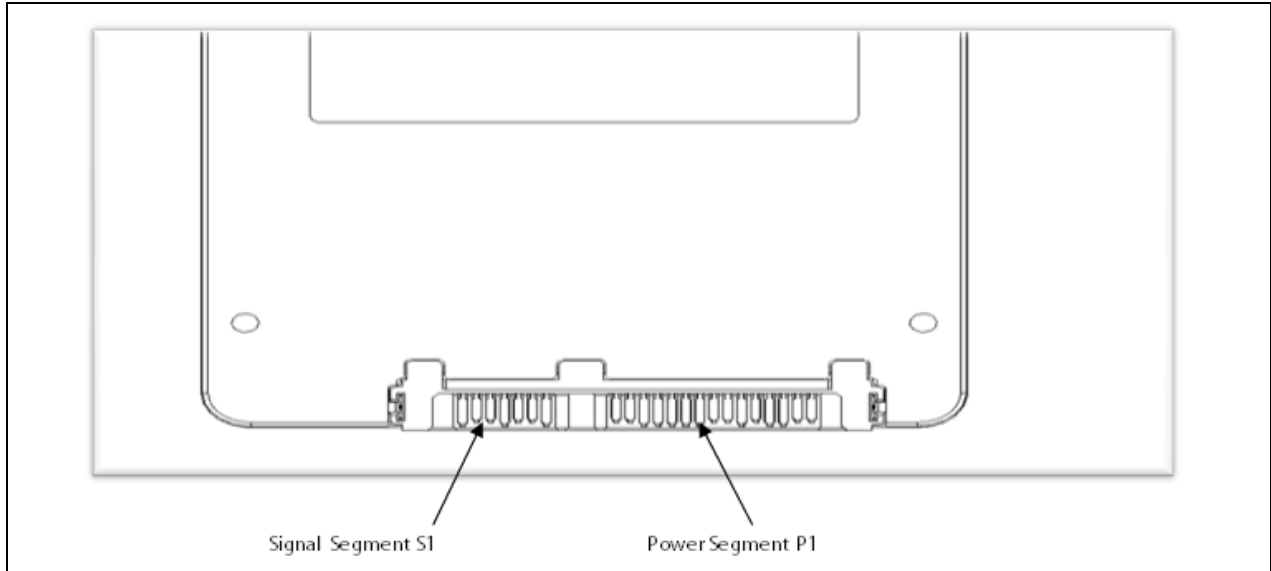

Note: 2.5-inch connector supports in-built latching capability.

4.2 Signal Descriptions

4.2.1 Connector Pin Signal Definitions

Table 10: Serial ATA Connector Pin Signal Definitions

Pin	Function	Definition
S1	Ground	1st mate
S2	A+	Differential signal pair A
S3	A-	
S4	Ground	1st mate
S5	B-	Differential signal pair B
S6	B+	
S7	Ground	1st mate

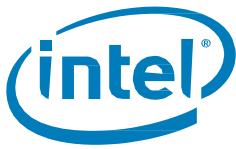

4.2.2 Power Pin Signal Definitions

Table 11: Serial ATA Power Pin Definitions

Pin ¹	Name	Definition	Mating Order
P1 ²	V ₃₃	3.3V Power; not used	2nd Mate
P2 ²	V ₃₃	3.3V Power; not used	2nd Mate
P3 ²	V ₃₃	3.3V Power; not used	2nd Mate
P4 ^{3,4}	Ground		1st Mate
P5 ³	Ground		1st Mate
P6 ³	Ground		1st Mate
P7 ^{3,5}	V ₅	5V Power	1st Mate
P8 ^{3,5}	V ₅	5V Power	2nd Mate
P9 ^{3,5}	V ₅	5V Power	2nd Mate
P10 ³	Ground		1st Mate
P11 ⁶	DAS	Device Activity Signal	2nd Mate
P12 ^{3, 4}	Ground		1st Mate
P13 ²	V ₁₂	12V Power	1st Mate
P14 ²	V ₁₂	12V Power	2nd Mate
P15 ²	V ₁₂	12V Power	2nd Mate

Note:

- All pins are in a single row, with a 1.27 mm (0.050-inch) pitch.
- Pins P1, P2 and P3 are connected together; Pins P13, P14 and P15 are connected together. Although they are not connected internally to the device, the host may apply voltage on these pins.
- The mating sequence is:
 - Ground pins P4-P6, P10, P12 and the 5V power pin P7.
 - Signal pins and the rest of the 5V power pins P8-P9.
- Ground connectors P4 and P12 may contact before the other 1st mate pins in both the power and signal connectors to discharge ESD in a suitably configured backplane connector.
- Power pins P7, P8, and P9 are internally connected to one another within the device.
- The host may ground P11 if it is not used for Device Activity Signal (DAS).

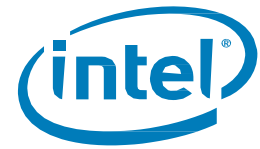

5 Supported Command Sets

The Intel® SSD 730 Series supports mandatory Advanced Technology Attachment (ATA*) and Serial ATA (SATA) commands defined in the ACS-2 and SATA Revision 3.0 specifications. The mandatory and optional commands are defined in this section.

5.1 ATA General Feature Command Set

General Feature command set (non-PACKET), which consists of:

- EXECUTE DEVICE DIAGNOSTIC
- FLUSH CACHE
- IDENTIFY DEVICE¹
- READ DMA
- READ SECTOR(S)
- READ VERIFY SECTOR(S)
- SEEK
- SET FEATURES
- WRITE DMA
- WRITE SECTOR(S)
- READ MULTIPLE
- SET MULTIPLE MODE
- WRITE MULTIPLE

The Intel SSD 730 Series also supports the following optional commands:

- READ BUFFER
- WRITE BUFFER
- NOP
- DOWNLOAD MICROCODE

Note:

1. See the Appendix for details on the sector data returned after issuing an IDENTIFY DEVICE command.

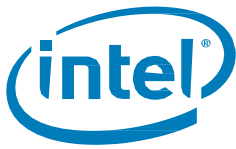

5.2 Power Management

The Intel® SSD 730 Series supports several power management feature sets as defined by the ATA specification: general Power Management feature set, Advanced Power Management feature set, and Power-Up in Standby (PUIS) feature set.

The Advanced Power Management and PUIS features can be enabled or disabled using the SET FEATURES command.

The Power Management feature set includes the following commands:

- CHECK POWER MODE
- IDLE
- IDLE IMMEDIATE
- SLEEP
- STANDBY
- STANDBY IMMEDIATE

5.3 SMART Command Set

The Intel SSD 730 Series supports the SMART command set, which consists of:

- SMART READ DATA
- SMART READ ATTRIBUTE THRESHOLDS
- SMART ENABLE/DISABLE ATTRIBUTE AUTOSAVE
- SMART SAVE ATTRIBUTE VALUES
- SMART EXECUTE OFF-LINE IMMEDIATE
- SMART READ LOG SECTOR
- SMART WRITE LOG SECTOR
- SMART ENABLE OPERATIONS
- SMART DISABLE OPERATIONS
- SMART RETURN STATUS
- SMART ENABLE/DISABLE AUTOMATIC OFFLINE

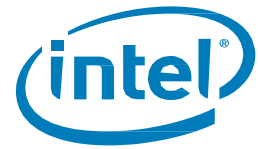

5.3.1 SMART Attributes

Table 12 lists the SMART attributes supported by the Intel® SSD 730 Series; Table 13 lists the corresponding status flags and threshold settings.

Table 12: SMART Attributes

ID	Attribute	Status Flags						Threshold
		SP	EC	ER	PE	OC	PW	
05h	Re-allocated Sector Count The raw value of this attribute reports the number of retired blocks since leaving the factory (grown defect count).	1	1	0	0	1	0	0 (none)
09h	Power-On Hours Count The raw value reports power-on time, cumulative over the life of the SSD, in hour time units. Normalized value: always 100	1	1	0	0	1	0	0 (none)
0Ch	Power Cycle Count The raw value of this attribute reports the cumulative number of power cycle events over the life of the device.	1	1	0	0	1	0	0 (none)
AAh	Available Reserved Space	1	1	0	0	1	1	10
ABh	Program Fail Count The raw value of this attribute reports total count of program fails and the normalized value, beginning at 100, The raw value of this attribute reports the percent remaining of allowable program fails.	1	1	0	0	1	0	0 (none)
ACh	Erase Fail Count The raw value of this attribute shows total count of erase fails and the normalized value, beginning at 100, shows the percent remaining of allowable erase fails.	1	1	0	0	1	0	0 (none)
A Eh	Unexpected Power Loss The raw value of this attribute reports the cumulative number of unsafe (unclean) shutdown events over the life of the device. An unsafe shutdown occurs whenever the device is powered off without STANDBY IMMEDIATE being the last command	1	1	0	0	1	0	0 (none)
B7h	SATA Downshift Count The raw value reports the number of times the SATA interface selected lower signaling rate due to error.	1	1	0	0	1	0	0 (none)
BBh	Uncorrectable Error Count The raw value reports the count of errors that could not be recovered using Error Correction Code (ECC).	1	1	0	0	1	0	0 (none)

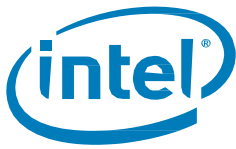

ID	Attribute	Status Flags						Threshold
		SP	EC	ER	PE	OC	PW	
C0h	<p>Power-Off Retract Count (Unsafe Shutdown Count)</p> <p>The raw value of this attribute reports the cumulative number of unsafe (unclean) shutdown events over the life of the device. An unsafe shutdown occurs whenever the device is powered off without STANDBY IMMEDIATE being the last command.</p>	1	1	0	0	1	0	0 (none)
C5h	<p>Pending Sector Count</p> <p>The raw value of this attribute reports the number of current unrecoverable read errors that will be re-allocated on next write.</p>	0	1	0	0	1	0	0 (none)
C7h	<p>CRC Error Count</p> <p>The raw value of this attribute reports the total number of encountered SATA interface cyclic redundancy check errors.</p>	1	1	0	0	1	0	0 (none)
E1h	<p>Host Writes</p> <p>The raw value of this attribute reports the total number of sectors written by the host system. The raw value is increased by 1 for every 65,536 sectors (32 MB) written by the host.</p>	1	1	0	0	1	0	0 (none)
E2h	<p>Timed Workload Media Wear</p> <p>The raw value of this attribute reports the wear seen by the SSD (since reset of the workload timer, attribute E4h), as a percentage of the maximum rated cycles.</p>	1	1	0	0	1	0	0 (none)
E3h	<p>Timed Workload Host Read/Write Ratio</p> <p>The raw value of this attribute reports the percentage of I/O operations that are read operations (since reset of the workload timer, attribute E4h).</p>	1	1	0	0	1	0	0 (none)
E4h	<p>Timed Workload Timer</p> <p>The raw value of this attribute reports the elapsed time (number of minutes since starting this workload timer).</p>	1	1	0	0	1	0	0 (none)
E8h	<p>Available Reserved Space</p> <p>This attribute reports the number of reserve blocks remaining. The normalized value begins at 100 (64h), which corresponds to 100 percent availability of the reserved space. The threshold value for this attribute is 10 percent availability.</p>	1	1	0	0	1	1	10
E9h	<p>Media Wearout Indicator</p> <p>This attribute reports the number of cycles the NAND media has undergone. The normalized value declines linearly from 100 to 1 as the average erase cycle count increases from 0 to the maximum rated cycles.</p> <p>Once the normalized value reaches 1, the number will not decrease, although it is likely that significant additional wear can be put on the device.</p>	1	1	0	0	1	0	0 (none)

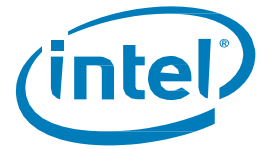

F1h	Total LBAs Written The raw value of this attribute reports the total number of sectors written by the host system. The raw value is increased by 1 for every 65,536 sectors (32 MB) written by the host.	1	1	0	0	1	0	0 (none)
F2h	Total LBAs Read The raw value of this attribute reports the total number of sectors read by the host system. The raw value is increased by 1 for every 65,536 sectors (32 MB) read by the host.	1	1	0	0	1	0	0 (none)

Table 13: SMART Attribute Status Flags

Status Flag	Description	Value = 0	Value = 1
SP	Self-preserving attribute	Not a self-preserving attribute	Self-preserving attribute
EC	Event count attribute	Not an event count attribute	Event count attribute
ER	Error rate attribute	Not an error rate attribute	Error rate attribute
PE	Performance attribute	Not a performance attribute	Performance attribute
OC	Online collection attribute	Collected only during offline activity	Collected during both offline and online activity
PW	Pre-fail warranty attribute	Advisory	Pre-fail

5.3.2 SMART Logs

The Intel® SSD 730 Series implements the following Log Addresses: 00h, 02h, 03h, 06h, and 07h.

The Intel SSD 730 Series implements host vendor specific logs (addresses 80h-9Fh) as read and write scratchpads, where the default value is zero (0). The Intel SSD 730 Series does not write any specific values to these logs unless directed by the host through the appropriate commands.

The Intel SSD 730 Series also implements a device vendor specific log at address A9h as a read-only log area with a default value of zero (0).

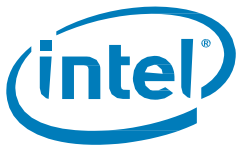

5.4 Device Statistics

In addition to the SMART attribute structure, statistics pertaining to the operation and health of the Intel® SSD 730 Series can be reported to the host on request through the Device Statistics log as defined in the ATA specification.

The Device Statistics log is a read-only GPL/SMART log located at read log address 0x04 and is accessible using READ LOG EXT, READ LOG DMA EXT or SMART READ LOG commands.

Table 14 lists the Device Statistics supported by the Intel SSD 730 Series.

Table 14: Device Statistics Log

Page	Offset	Description	Equivalent SMART attribute if applicable
0x00	-	List of Supported Pages	-
0x01 - General Statistics	0x08	Power Cycle Count	0Ch
	0x10	Power-On Hours	09h
	0x18	Logical Sectors Written	E1h
	0x28	Logical Sectors Read	F2h
0x04 - General Errors Statistics	0x08	Num Reported Uncorrectable Errors	BBh
	0x10	Num Resets Between Command Acceptance and Completion	-
0x06 - Transport Statistics	0x08	Num Hardware Resets	-
	0x10	Num ASR Events	-
	0x18	Num Interface CRC Errors	-
0x07 - Solid State Device Statistics	0x08	Percentage Used Endurance Indicator	E9h This statistic counts up from 0 rather than down from 100, and may go beyond 100 for drives that exceed their expected lifetime.

5.5 SMART Command Transport

With SMART Command Transport (SCT), a host can send commands and data to an SSD and receive status and data from an SSD using standard write/read commands to manipulate two SMART Logs:

- Log Address E0h ("SCT Command/Status") — used to send commands and retrieve status
- Log Address E1h ("SCT Data Transfer") — used to transport data

5.6 Data Set Management Command Set

The Intel SSD 730 Series supports the Data Set Management command set Trim attribute, which consists of:

- DATA SET MANAGEMENT

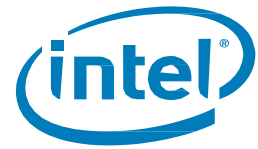

5.7 Host Protected Area Command Set

The Intel® SSD 730 Series supports the Host Protected Area Management command set which consists of:

- READ NATIVE MAX ADDRESS
- SET MAX ADDRESS
- READ NATIVE MAX ADDRESS EXT
- SET MAX ADDRESS EXT

5.8 48-Bit Address Command Set

The Intel SSD 730 Series supports the 48-bit Address command set, which consists of:

- FLUSH CACHE EXT
- READ DMA EXT
- READ NATIVE MAX ADDRESS EXT
- READ SECTOR(S) EXT
- READ VERIFY SECTOR(S) EXT
- SET MAX ADDRESS EXT
- WRITE DMA EXT
- WRITE MULTIPLE EXT
- WRITE SECTOR(S) EXT
- WRITE MULTIPLE FUA EXT
- WRITE DMA FUA EXT

5.9 General Purpose Log Command Set

The Intel SSD 730 Series supports the General Purpose Log command set, which consists of:

- READ LOG EXT
- WRITE LOG EXT

5.10 Native Command Queuing

The Intel SSD 730 Series supports Native Command Queuing command set which consists of:

- READ FPDMA QUEUED
- WRITE FPDMA QUEUED

5.11 Software Settings Preservation

The Intel SSD 730 Series supports the SET FEATURES parameter to enable/disable the preservation of software settings.

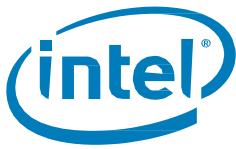

6 Certifications and Declarations

Table 15 describes the Device Certifications supported by the Intel® SSD 730 Series.

Table 15: Device Certifications and Declarations

Certification	Description
CE* Compliant	European Economic Area (EEA): Compliance with the essential requirements of EC Council Directives Low Voltage Directive (LVD) 2006/95/EC, EMC Directive 2004/108/EC and Directive 2011/65/EU.
UL* Certified	Certified Underwriters Laboratories, Inc. Bi-National Component Recognition; UL 60950-1, 2nd Edition, 2007-03-27 (Information Technology Equipment - Safety - Part 1: General Requirements) CSA C22.2 No. 60950-1-07, 2nd Edition, 2007-03 (Information Technology Equipment - Safety - Part 1: General Requirements)
C-Tick* Compliant	Compliance with the Australia/New Zealand Standard AS/NZS3548 and Electromagnetic Compatibility (EMC) Framework requirements of the Australian Communication Authority (ACA).
BSMI* Compliant	Compliance to the Taiwan EMC standard CNS 13438: Information technology equipment - Radio disturbance Characteristics - limits and methods of measurement, as amended on June 1, 2006, is harmonized with CISPR 22: 2005.04.
KCC*	Compliance with paragraph 1 of Article 11 of the Electromagnetic Compatibility Control Regulation and meets the Electromagnetic Compatibility (EMC) Framework requirements of the Radio Research Laboratory (RRL) Ministry of Information and Communication Republic of Korea.
Microsoft* WHCK*	Microsoft Windows* Hardware Certification Kit
RoHS* Compliant	Restriction of Hazardous Substance Directive
VCCI*	Voluntary Control Council for Interface to cope with disturbance problems caused by personal computers or facsimile.
SATA-IO	Indicates certified logo program from Serial ATA International Organization.
Low Halogen	Applies only to brominated and chlorinated flame retardants (BFRs/CFRs) and PVC in the final product. Intel components as well as purchased components on the finished assembly meet JS-709 requirements, and the PCB/substrate meet IEC 61249-2-21 requirements. The replacement of halogenated flame retardants and/or PVC may not be better for the environment.



7 Appendix

Table 16 describes the sector data returned from an Identify Device command.

Table 16: Identify Device Returned Sector Data

Word	F = Fixed V = Variable X = Both	Default Value	Description
0	X	0040h	General configuration bit-significant information
1	X	3FFFh	Obsolete - Number of logical cylinders (16,383)
2	V	C837h	Specific configuration
3	X	0010h	Obsolete - Number of logical heads (16)
4-5	X	0h	Retired
6	X	003Fh	Obsolete - Number of logical sectors per logical track (63)
7-8	V	0h	Reserved for assignment by the CompactFlash* Association (CFA)
9	X	0h	Retired
10-19	F	varies	Serial number (20 ASCII characters)
20-21	X	0h	Retired
22	X	0h	Obsolete
23-26	F	varies	Firmware revision (8 ASCII characters)
27-46	F	varies	Model number (Intel® Solid-State Drive)
47	F	8001h	7:0—Maximum number of sectors transferred per interrupt on multiple commands
48	F	4000h	Trusted Computing Feature Set
49	F	2F00h	Capabilities
50	F	4000h	Capabilities
51-52	X	0h	Obsolete
53	F	0007h	Words 88 and 70:64 valid
54	X	3FFFh	Obsolete - Number of logical cylinders (16,383)
55	X	0010h	Obsolete - Number of logical heads (16)
56	X	003Fh	Obsolete - Number of logical sectors per logical track (63)
57-58	X	FC1000FBhh	Obsolete
59	F	B101h	Number of sectors transferred per interrupt on multiple commands
60-62	V	varies	Total number of user-addressable sectors
63	X	0007h	Multi-word DMA modes supported/selected
64	F	0003h	PIO modes supported
65	F	0078h	Minimum multiword DMA transfer cycle time per word
66	F	0078h	Manufacturer's recommended multiword DMA transfer cycle time
67	F	0078h	Minimum PIO transfer cycle time without flow control
68	F	0078h	Minimum PIO transfer cycle time with IORDY flow control
69	F	4020h	Additional Supported

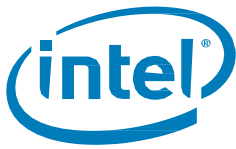

Word	F = Fixed V = Variable X = Both	Default Value	Description
70	F	0h	Reserved
71-74	F	0h	Reserved for IDENTIFY PACKET DEVICE command
75	F	001Fh	Queue depth
76	F	850Eh	Serial ATA capabilities
77	F	0006h	Reserved for future Serial ATA definition
78	F	0040h	Serial ATA features supported
79	V	0040h	Serial ATA features enabled
80	F	01FCh	Major version number
81	F	0029h	Minor version number
82	F	746Bh	Command set supported
83	F	7501h	Command sets supported
84	F	6163h	Command set/feature supported extension
85	X	7469h	Command set/feature enabled
86	X	B401h	Command set/feature enabled
87	X	6163h	Command set/feature default
88	X	407Fh	Ultra DMA Modes
89	F	0001h	Time required for security erase unit completion
90	F	0001h	Time required for enhanced security erase completion
91	V	0h	Current advanced power management value
92	V	0FFEh	Master Password Revision Code
93	X	0h	Hardware reset result: the contents of bits (12:0) of this word shall change only during the execution of a hardware reset
94	V	0h	Vendor's recommended and actual acoustic management value
95	F	0h	Stream minimum request size
96	V	0h	Streaming transfer time - DMA
97	V	0h	Streaming access latency - DMA and PIO
98-99	F	0h	Streaming performance granularity
100-103	V	varies	Maximum user LBA for 48-bit address feature set
104	V	0h	Streaming transfer time - PIO
105	V	0006h	Maximum number of 512-byte blocks of LBA Range Entries per DATA SET MANAGEMENT command
106	F	4000h	Physical sector size / logical sector size
107	F	0h	Inter-seek delay for ISO-7779 acoustic testing in microseconds
108-111	F	varies	Unique ID
112-115	F	0h	Reserved for world wide name extension to 128 bits
116	V	0h	Reserved for technical report
117-118	F	0h	Words per logical sector
119	F	405Ch	Supported settings
120	X	401Ch	Command set/feature enabled/supported

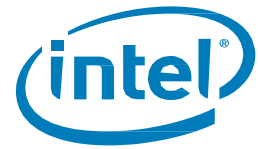

Intel® Solid-State Drive 730 Series

Word	F = Fixed V = Variable X = Both	Default Value	Description
121-126	F	0h	Reserved
127	X	0h	Removable Media Status Notification feature set support
128	X	0021h	Security status
129	V	001Eh	Vendor-specific
130-159	X	0h	Vendor-specific
160	X	0h	CompactFlash Association (CFA) power mode 1
161-167	X	0h	Reserved for assignment by the CFA
168	X	0003h	Reserved for assignment by the CFA
169	X	0001h	Data set management Trim attribute support
170-175	F	0h	Reserved
176-205	V	Varies	Current media serial number
206	X	003Dh	SCT Command Transport
207-208	F	0h	Reserved
209	X	4000h	Alignment of logical blocks within a physical block
210-211	V	0h	Write-Read-Verify Sector Count Mode 3 (DWord)
212-213	F	0h	Write-Read-Verify Sector Count Mode 2 (DWord)
214	X	0h	NV Cache Capabilities
215-216	V	0h	NV Cache Size in Logical Blocks (DWord)
217	F	0001h	Nominal media rotation rate
218	V	0h	Reserved
219	F	0h	NV Cache Options
220	V	0h	Write-Read-Verify feature set
221	X	0h	Reserved
222	F	101Fh	Transport major version number
223	F	0h	Transport minor version number
224-229	F	0h	Reserved
230-233	X	0h	Extended Number of User Addressable Sectors (QWord)
234	F	0001h	Minimum number of 512-byte data blocks per DOWNLOAD MICROCODE command for mode 03h
235	F	FFFFh	Maximum number of 512-byte data blocks per DOWNLOAD MICROCODE command for mode 03h
236-254	X	0h	Reserved
255	V	varies	Integrity word

Note:

F = Fixed. The content of the word is fixed and does not change. For removable media devices, these values may change when media is removed or changed.

V = Variable. The state of at least one bit in a word is variable and may change depending on the state of the device or the commands executed by the device.

X = F or V. The content of the word may be fixed or variable.