



Designed to block nuisance calls

Quick Set-up and User Guide



BT6610 Nuisance Call Blocker
Digital Cordless Phone with Answering Machine

Important – please read first

- Only use the line cord, power supply and rechargeable batteries supplied with your phone.
- Make sure that the power supply is connected to a known working socket.
- Connect your phone to the power supply and allow the batteries to charge for 24 hours before connecting the line cord to your telephone socket.
- To make sure you get the best range and reception from your handset, avoid interference by placing the base unit away from large metal objects such as fridge freezers and microwave ovens or electronic products such as computers and TVs.

Answer machine – handy hint

Make sure the telephone is set to 'Answer and record' and that the Ring delay is set to answer before any voicemail service i.e. BT Answer 1571, or similar. The default setting is four rings. If you want to change this, please see page 47-48.

Check box contents



Handset



Base

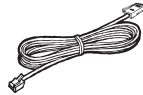

Telephone line cord
(pre-installed)



Mains power adaptor
(item code 066270)



2 x AAA Ni-MH 750 mAh
rechargeable batteries
(already in handset)

Contents for each additional handset (multipacks only)



Handset



Charger



Mains power adaptor
(item code 066270)



2 x AAA Ni-MH 750 mAh
rechargeable batteries
(already in handset)

! Important

Only use the mains power adaptors, cables and rechargeable batteries supplied in this box or this product might not work. Any replacement rechargeable batteries must be of the same type. BT accepts no responsibility for damage caused to your BT6610 if you use any other type of batteries.

Quick set-up guide

Where to put your phone

- Place the base within 3 metres of a mains power socket and 3 metres of a phone socket so the cables will reach.
- Make sure it's at least a metre away from other electrical appliances to avoid interference.
- Don't place the phone or base in a bathroom or other humid area.
- The product works by sending radio signals between the handset and base. The strength of the signal depends on where you position the base. Putting it as high as possible can help give you the best signal.

IMPORTANT

- Don't connect the phone line to a phone socket until the handset is fully charged.
- The base station should be plugged into the mains power socket all the time.

1 Plug in

1. Plug the mains power adaptor into the base, with the cable clipped in the groove provided.
2. Plug the other end of the power adaptor into the wall power socket and switch on.

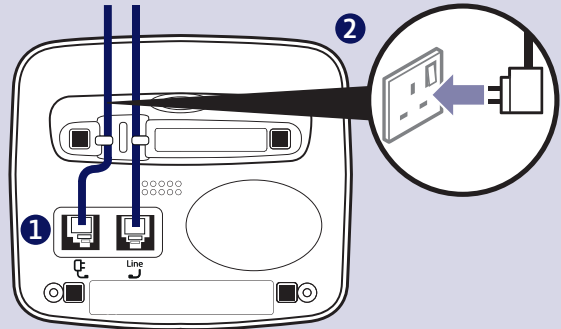

The phone line cord is pre-installed but **don't** plug the other end into the wall socket yet.

- !** Turn the cable when clipping into the groove so that the narrow part fits between the clips before turning cable back to secure.

2 Activate the batteries and charge

1. Activate the batteries by pulling the plastic tab away from the bottom of the handset.

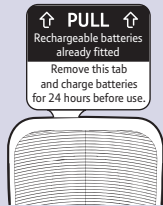

2. The BT logo will appear on the screen, followed by the set up wizard screen displaying **Please set the time and date to start using your telephone.** Don't follow these instructions yet. Place your handset on the base to charge first.
3. Place the handset on the base and leave to charge for 24 hours.

! IMPORTANT

Charge the handset batteries for 24 hours or your phone might not work.

Talk/Standby time

Under ideal conditions, the handset batteries should give up to 22 hours talk time or 240 hours standby on a single charge. (This doesn't mean you can unplug the base or leave the handset for this length of time without charge).

Please note that new Ni-MH rechargeable batteries don't reach full capacity until they've been in normal use for several days.

Battery low warning

The  icon will flash, you'll see the message **Battery low** in the display and hear a warning beep every minute, to indicate that you need to recharge your handset. You can remove the display message by selecting **Hide**. If the battery charge completely runs out, the display will show **Batteries flat. Please charge.** You must recharge the handset batteries before you can use the handset. If the charge completely runs out the handset will switch off. Place the handset on the base or charger to charge.

6 Quick set-up guide

Battery performance

- To keep the batteries in the best condition, leave the handset off the base for a few hours at a time.
- Running the batteries right down at least once a week will help them last as long as possible.
- After charging your handset for the first time, subsequent charging time for the batteries is approximately 8 hours.
- The charge capacity of rechargeable batteries will go down over time, which will reduce the talk and standby time. Eventually they'll need replacing. For details on how to get replacement batteries, call the helpline on 0800 145 6789*.

! If your screen displays this message, don't worry. This is normal and will continue to be displayed until you connect the phone line cord in step 4.

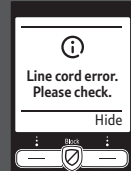

4. After 24 hours, plug the phone line cord into the phone wall socket.

3 Follow the set up wizard

Follow the set up wizard to set the time and date, record your outgoing message for the answer machine, set up call blocking and add contacts. Select **YES** by pressing the Left option button **←** if you want to follow the set-up wizard prompt or select **NO** by pressing the Right option button **→** to continue to the next prompt until set-up is complete.

4 Set up your additional handsets (multipacks only)

1. For additional handsets and chargers: plug the mains power adaptor into the back of the charger and plug the other end into the mains wall socket and switch on the power.

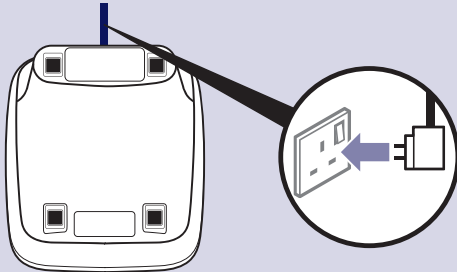

2. Activate the batteries as explained on page 5. If you set the time and date on the first handset then it will be shared with all other handsets in your multipack once you activate the batteries.
3. Place the handset on the charger to charge for 24 hours.

Using your BT6610 on a broadband line?

To avoid problems with your broadband or noise on your phone line, you might need to plug it into the wall socket via a microfilter (not supplied).

If your main phone socket has a **single** socket, you **do** need to use microfilters, like this:

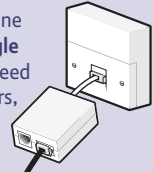

You'll need a microfilter for every phone socket where you've got equipment plugged in – up to a maximum of four per line – including alarm systems and digital TV boxes.

You can get BT ADSL microfilters from bt.com/shop

You **don't** need to use microfilters if your main phone socket has **two separate** sockets, like these:

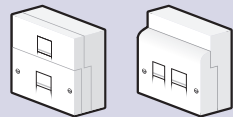

! If you ever need to remove the batteries, place your fingers in the groove at the bottom of the handset and lift the cover up to release it. Then, gently ease the batteries out.

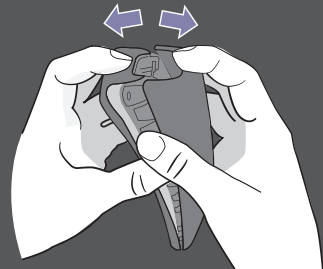





5 Go!

Your BT6610 is now ready for you to use

- For instructions on making a call, go to page 22.
- For help personalising your phone's settings, go to page 59.
- For instructions on using the answer machine, go to page 44.

6 Block nuisance calls

The BT6610 blocks numbers in two separate ways to help you avoid nuisance calls, firstly by type e.g withheld or international and also by your choice of specific numbers (you can store up to 100 numbers of your own choice).

1. Select **Menu**, scroll  to **Call Control** and press **Select**.
2. Follow the instructions to set your PIN for the first time and select **OK**, (see page 55).
3. **Incoming calls** is displayed, press **Select**.
4. Press  to highlight **Block calls** and press **Select**. You now have 2 choices:
 - i) To block calls by type, when **By call type** is highlighted, press **Select**. Select **Blocked** or **Allowed** for each of the call types by highlighting each one using  and : **International**, **Withheld number**, **No Caller ID** and **Payphone**, then select **Save**.
 - ii) To block calls by a specific number, press  to highlight **By number** and press **Select**. You will enter the blocked numbers list, press **Options** and

Please note, other products connected to the line are not compatible with this feature and will still ring.

You must subscribe to a Caller Display service from your network provider for the block nuisance calls feature to work. Charges may apply.

Blocked will be displayed with no backlight on the handset when a blocked call is received. The handset or base will not ring.

10 Quick set-up guide

For more information and general advice on handling unwanted calls please go to bt.com/unwantedcalls

Please note, other products connected to the line are not compatible with this feature and will still ring.

For more information on Call control settings, go to page 28.

No PIN number is required when using the block call button when there is an incoming call or during a call.

If you cannot find the answer to your problem in this user guide, then please call our free Helpline on 0800 145 6789*. Our dedicated advisors are more likely to be able to help you than the retailer where you made your purchase.

select **Add**. Enter the number you want to block (or you can select **Options** and select a number from your contacts or calls list) then select **Save**.

The Block button

The block call button can be used in 3 ways:

On incoming calls, during a call and in idle mode, see page 30 under Call control settings.

7 Help

Most problems can be fixed with a few simple checks, you may find the answer in the Help section on page 80 or see our online frequently asked questions at bt.com/producthelp. Alternatively, call the Helpline on 0800 145 6789*.

* Calls made from within the UK mainland network are free. Mobile and international call costs may vary.

In this guide

Getting to know your phone

Handset buttons	15
Handset display/display icons	17
Finding your way around your phone	18
Menu map.....	19
Base.....	21

Using the phone

Switch the handset on or off	22
Make an external call	22
Preparatory dialling	22
End a call.....	22
Call timer.....	22
Receive a call.....	22
Call Waiting	23
Mute.....	24
Incoming speech/Handsfree volume .	24
Handsfree	25
Make a handsfree call.....	25
Answer a call handsfree.....	25
Switch to handsfree during a call	25

Redial	25
Voicemail (1571)	26
Keypad lock.....	26
Turn the handset ringer on or off.....	27
Finding handset (paging)	27

Call control settings

Set-up Do not disturb	28
Block nuisance calls	29
The block button	30
Set Parental Controls.....	32
Assign VIPs.....	32
Change the access PIN	33

Contacts

Store a contact name and number	34
Character map	35
View/dial a contact	35
Edit a contact entry.....	36
Delete selected or all contacts.....	36
View the contact memory status.....	37

Speed dial

Save a speed dial entry.....38
 Dial a speed dial entry38
 Edit a speed dial entry.....39
 Delete a speed dial entry39

Caller Display and the Calls list

Caller Display.....40
 Calls list.....40
 Missed call notification.....41
 View and access options in
 the Calls list41
 Save a Calls list entry to your contacts42
 Delete an entry in or the entire
 Calls list.....43

Answer machine

Using the answer machine from
 the handset.....44
 Switch the answer machine on or off
 and set the answer mode.....44
 Outgoing messages.....45
 Record your own outgoing message..45

Play the current outgoing message ...46
 Reinstate the pre-recorded
 outgoing message46
 Record a memo47
 Answer delay.....47
 Set the answer delay48
 Set the maximum message length....48
 Set the message alert on or off49
 Call screening via the handset.....49
 Turn call screening on or off.....49
 Using call screening50
 Message playback using the handset 50
 Delete a message or delete all old
 (played) messages52
 Save a number in the answer phone
 message list to your contacts.....52
 Send a text to a number in the
 answer phone message list53
 Using the answer machine from
 the base53
 Switch the answer machine on or off.53

13 In this guide

Message playback using the base.....	54	Set the base ringtone melody and volume	61
Delete all old (played) messages	55	Set a PBX access code	62
Remote access.....	55	Change the system PIN.....	62
Set the remote access PIN for the first time	55	Turn Eco mode on or off	63
Change the remote access PIN	56	Reset the handset or base settings	63
Turn remote access on/off	56	Clear the handset or base user data ..	64
If you forget to switch on your answer machine.....	57	Clock/Alarm	
Operating your answer machine remotely	58	Set the time and date.....	65
		Set the time format (12 or 24 hour) ..	65
		Set an alarm	66
		Stopping the alarm when it goes off..	66
		BT Calling Features	
		Pre-stored numbers in the Calling Features menu.....	67
		Using Call Diversion.....	67
		Cancel Ringback	68
		Using Call Waiting	68
Settings			
Set the handset ringtone for external or internal calls and the ringer volume ..	59		
Turn the alert tones on or off	59		
Turn the handset tones on or off	60		
Change the handset display contrast ..	60		
Change the handset name	60		
Change the call settings (auto answer, Autoend call, Autojoin and first ring) ..	61		

Text messaging

Register to the text messaging service.....	69
Send a text message	70
Receiving text messages.....	71
Reading messages	72
Accessing the Inbox, Drafts folder or Sent folder	73
Edit a template	74
Turn new text message alert on or off.....	74
Service centre numbers.....	75
Change the service centre numbers...	75

Using additional handsets

Registering an additional handset.....	76
De-register a handset	77
Make an internal call between handsets.....	78
Transfer a call.....	78
Hold a 3-way call.....	79

Help	80
-------------------	----

General information

Safety information	87
Cleaning.....	88
Environmental.....	88
How to recycle your equipment	88
Guarantee	89
Technical information.....	90
Connecting to a switchboard	90
Recall (R).....	90
R&TTE	90
Declaration of Conformance	90

Getting to know your phone

Handset buttons

Left option button

In idle mode, press to enter the main menu.
Also use to access sub menus and confirm options shown on the display above the button.

Up/Volume

In idle mode, press to change the ringer volume, see page 59.
In talk mode, press to increase the incoming speech volume.
In menu mode, press to scroll up through the options.

Contacts

In idle mode, press to access your stored Contacts.

Talk/Handsfree

In idle mode, press to make and receive calls, see page 22.
In talk mode, press to switch handsfree on and off, see page 25.

Calls/Down

In idle mode, press to open and scroll through the Calls list, see page 40.
In talk mode, press to decrease the incoming speech volume.
In menu mode, press to scroll down through the options.

1 (Speed dial)

In idle mode, press and hold to dial BT 1571
or your stored speed dial number, see page 38.



Press and hold to turn the handset ringer on or off.

0

Press to enter a space.

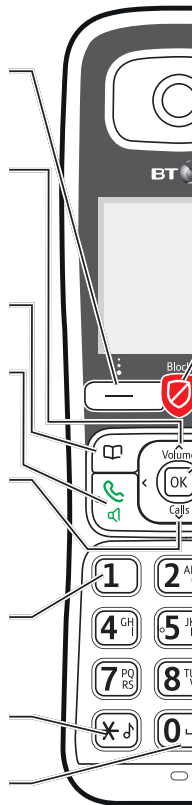

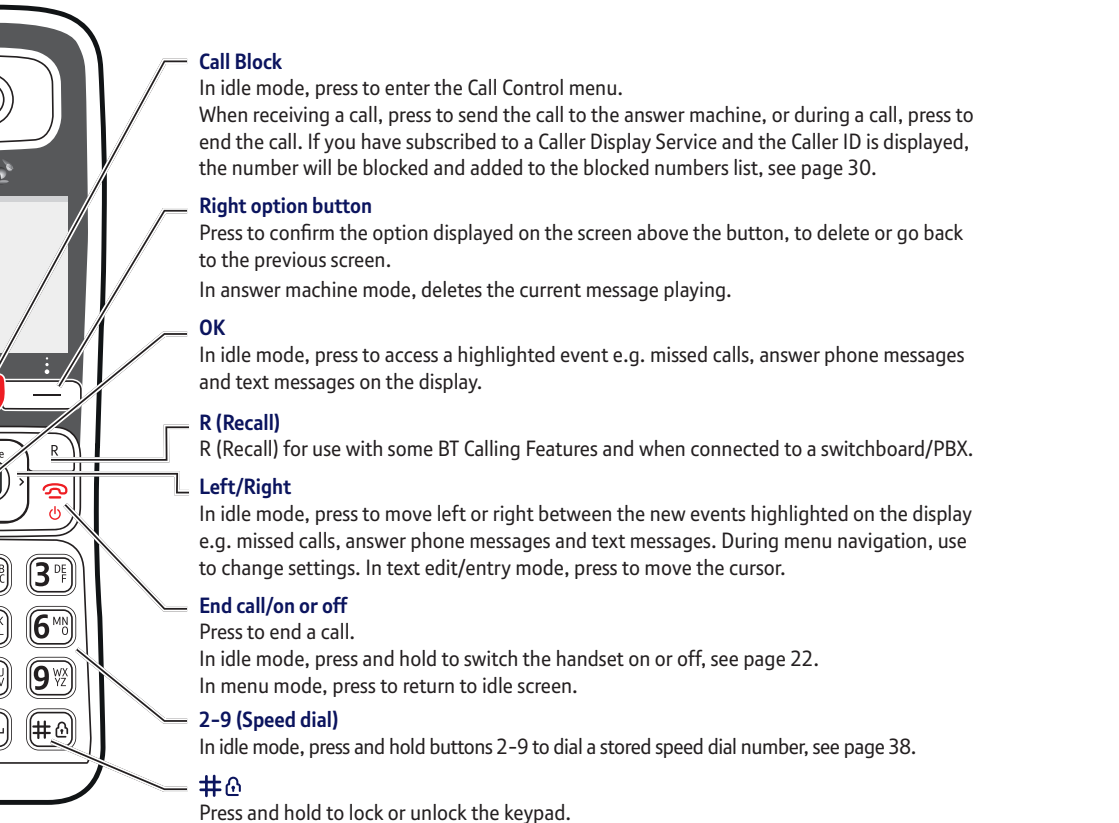
**Call Block**

In idle mode, press to enter the Call Control menu.

When receiving a call, press to send the call to the answer machine, or during a call, press to end the call. If you have subscribed to a Caller Display Service and the Caller ID is displayed, the number will be blocked and added to the blocked numbers list, see page 30.

Right option button

Press to confirm the option displayed on the screen above the button, to delete or go back to the previous screen.

In answer machine mode, deletes the current message playing.

OK

In idle mode, press to access a highlighted event e.g. missed calls, answer phone messages and text messages on the display.

R (Recall)

R (Recall) for use with some BT Calling Features and when connected to a switchboard/PBX.

Left/Right

In idle mode, press to move left or right between the new events highlighted on the display e.g. missed calls, answer phone messages and text messages. During menu navigation, use to change settings. In text edit/entry mode, press to move the cursor.

End call/on or off

Press to end a call.

In idle mode, press and hold to switch the handset on or off, see page 22.

In menu mode, press to return to idle screen.

2-9 (Speed dial)

In idle mode, press and hold buttons 2-9 to dial a stored speed dial number, see page 38.

#

Press and hold to lock or unlock the keypad.

17 Getting to know your phone

Handset display

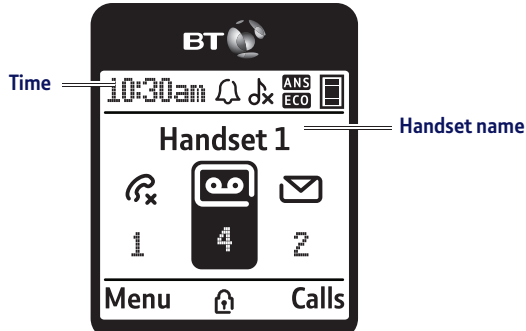

Handset display icons

 Shows handset battery status.
Scrolls when the handset is charging.

 Empty frame flashes when battery needs recharging.

 On – missed call(s) in the Calls list*.
With number of calls displayed.

 On – answer machine message(s) received with number of messages displayed.

 On – text message(s) received with number of messages displayed.

 On – Eco mode is on (for that handset).

 On – answer machine on.
Off – answer machine off.
Flashing – new answer machine message
Memory full displayed when the answer machine memory is full.

UnMute/Mute Indicates when Mute is on or off.

 On – alarm is set.
Flashing – alarm time has been reached.
Off – alarm off.

 The keypad is locked.

 Handset ringer is switched off.

* For full details of who has called you please make sure you have subscribed to Caller Display from your network provider.

Finding your way around your phone

Your BT6610 has an easy to use menu system. Each menu has a list of options, which you can see on the menu map on the next page.

When the handset is switched on and at the idle screen:

1. Select **Menu** by pressing the Left option button to open the main menu.
2. Use the **Volume** or **Calls** button to scroll through the available menu options.
3. When the menu you want is displayed, select by pressing the Left option button or press **OK**.
4. Use the **Volume** or **Calls** button to scroll through the available sub menu options. When the sub menu you want is highlighted, select by pressing the Left option button or press **OK**.

Select the **Back** option if you want to return to the previous screen.

To exit a menu and return to the idle screen, press .

If no buttons are pressed for 30 seconds, the handset returns to the idle screen automatically.



19 Getting to know your phone

Menu map

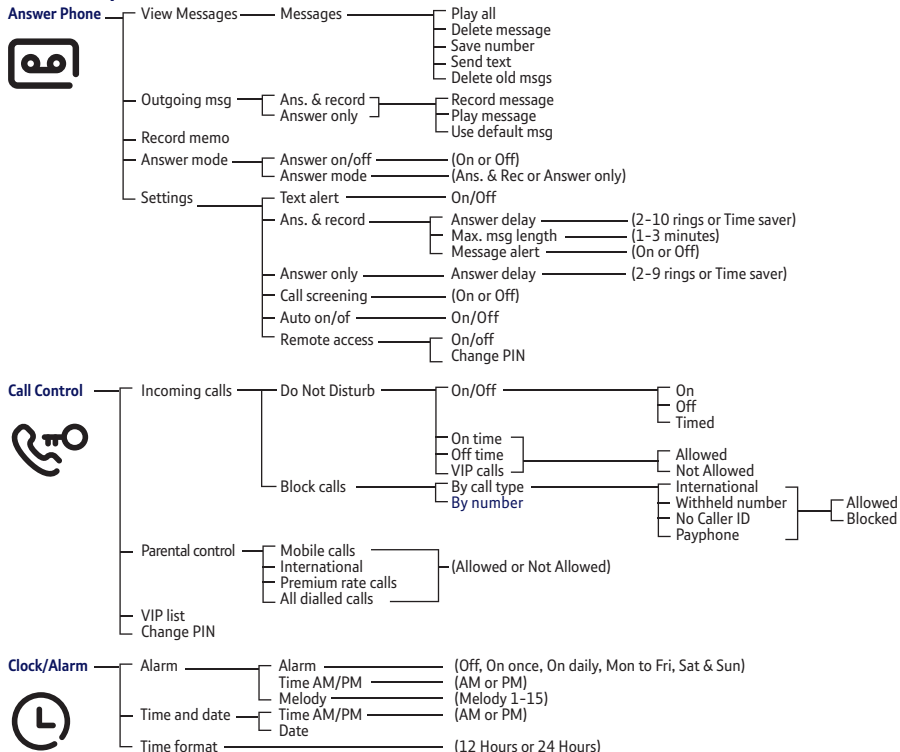

Text Messages

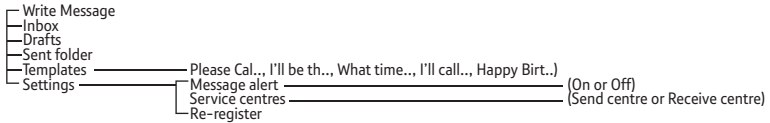

Speed Dial List — 1. 1571 2-9 Empty — (Edit or Delete)



BT Calling Features

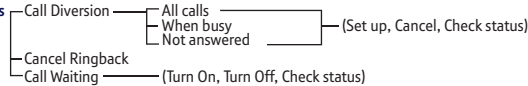

Settings

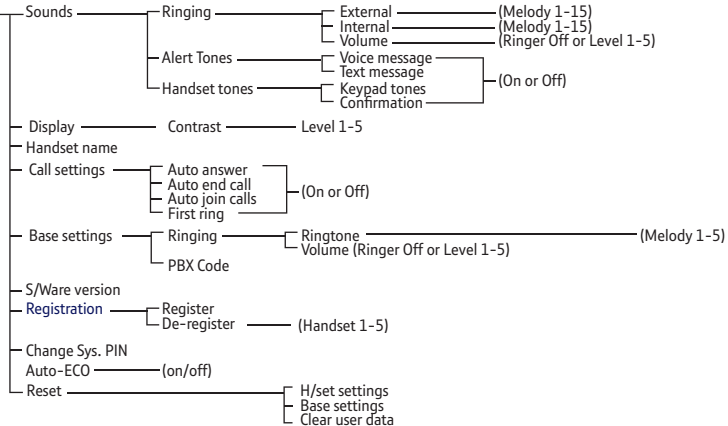

Contacts menu
Accessed by pressing the button then Options.

- Add new contact
- Edit contact
- Delete
- Memory status

Calls list Menu
accessed by pressing

- Play message*
- Save number
- Delete call
- Send text
- Block number
- Delete all

* If a message has been left on the answer machine.

Base

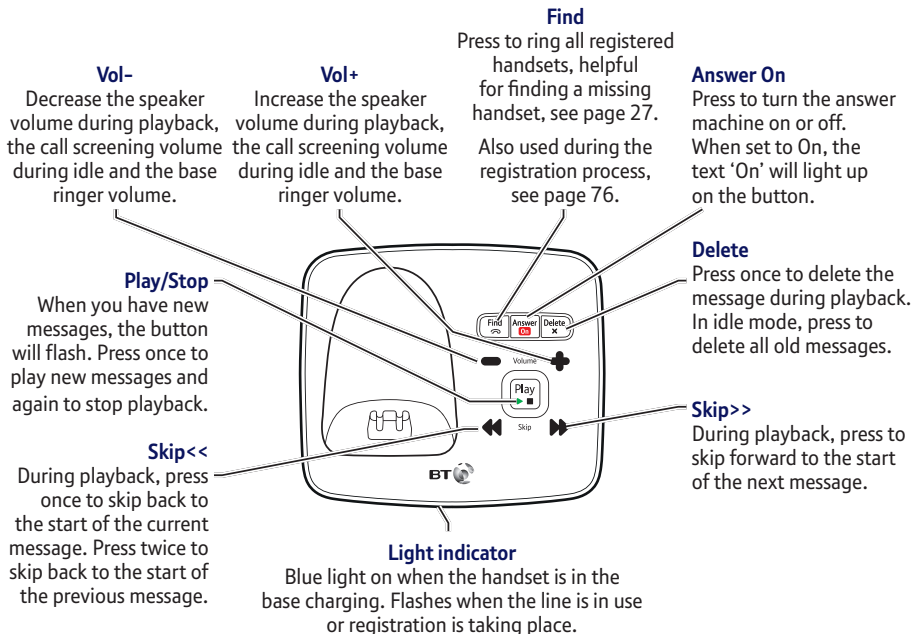

Using the phone

To switch the handset off

1. Press and hold  until the handset turns off.

To switch the handset on

1. Press and hold  until the handset turns on.



Make an external call

1. Press .
2. When you hear the dial tone, enter the number.

Preparatory dialling

1. Enter the number first. If you make a mistake select **Clear** by pressing the Right option button to delete the last digit.
2. Press  to dial.

End a call

1. Press . Or, press  to end the call and add the caller's number to the blocked numbers list, see page 30 (only blocks if the number is available and if you've subscribed to a Caller Display service).

Call timer

Your handset will automatically time your outgoing and incoming calls. The handset shows the length of time both during and for a few seconds after your call.

Auto end

If auto end is set to On you can end a call by placing the handset back in the base. If auto end is set to Off, you'll need to press  to end the call. Auto end On is the default setting. See page 61.

Out of range warning

When the handset is out of range of the base, the display will show **Searching for base...**, the backlight will turn up to 100% to indicate the alert message and you will hear a warning tone. After 60 seconds the display will show **No base link. Check base**. You need to move back within range of the base station.

If you move out of range when you're on a call, you'll lose your connection. The handset will automatically re-connect to the base when you move back within range.

23 Using the phone

Auto answer

Auto answer Off is the default setting to help with nuisance calls. See page 61. If auto answer is set to Off, you'll need to lift the handset off the base and press  to answer the call. If auto answer is set to On you can answer a call by just lifting the handset off the base.

Receive a call

When you receive a call, the phone rings and the display shows **Incoming call** and . If you've got a caller display service, the display shows the caller's number if it's available or the caller's name if it matches an entry stored in your contacts list.

1. To accept the call press .

Or

To block the call and send it to the answer phone (even if it is switched off), press  see page 30.

If you have subscribed to a Caller Display Service and if the number is displayed, the caller's telephone number will be added to the blocked numbers list.

Call Waiting

If you've got a call waiting service and it is switched on, your phone will alert you to a second incoming call if you're already engaged on an external call.

To switch your call waiting service on or off, see page 68.

1. You'll hear the call waiting tone and if you also have caller display the display will show the number of the caller, or the name if it matches an entry in your contacts.

2. Select **Switch** by pressing the Left option button to answer the new call and your first caller is put on hold.
3. Select **Switch** to toggle between the two callers.
4. Press  to hang up the current call.



Mute

During a call, you can talk to someone nearby without your caller hearing.

1. During a call, select **Mute** by pressing the Right option button. The display shows **Call muted** and your caller can't hear you.
2. Select **Unmute** to return to your caller.

Incoming speech / Handsfree volume

During a call, you can adjust the handset incoming speech or loudspeaker volume. There are five levels. The default setting is Level 3.

1. Press  or  to increase or decrease the volume. The first press will present the Call volume screen so you can see the current volume level. Subsequent presses will change the volume, you will hear the volume level with each press.





25 Using the phone

Handsfree

Handsfree lets you talk to your caller without holding the handset and means that other people in the room can listen to your conversation over the loudspeaker.



During a handsfree call, press  or  to change the volume.

Make a handsfree call

1. Enter the number then press  twice.  is displayed. You hear your call over the handset loudspeaker. Press  to switch the call between the earpiece and the loudspeaker.
2. Press  to end the call.

Answer a call handsfree

When the phone rings:

1. Press  after the call has been answered. The call is transferred to the handset loudspeaker. If Auto Answer is set to off (the default setting), you will need to press  twice.

Switch to handsfree during a call

1. During a call, press  to put the call on the loudspeaker. To switch handsfree off and return the call to the earpiece, press  again.

Redial

Telephone numbers that you have called are saved in the Calls list. There is not a separate redial list, all calls are saved in the Calls list. The Calls list holds up to 50 incoming (missed and answered) calls and 30 outgoing calls.

To redial a number, see 'View and access options in the Calls list' on page 41. You can also save a number you've called to your contacts, delete a number you've called or delete all numbers from the Calls list, see page 43.

Voicemail (BT 1571)

1. If you have subscribed to BT Answer 1571 you can press and hold **1** to listen to your messages.

Keypad lock

To lock the keypad

1. Press and hold **#*#** for 2 seconds. The handset gives a confirmation tone and **Keypad locked** is briefly displayed before returning to the idle screen with the  icon displayed.

To unlock the keypad

1. Press and hold **#*#** for 2 seconds. The handset gives a confirmation tone and **Keypad unlocked** is briefly displayed before returning to idle.

You can lock the keypad so that it can't be used accidentally while you're carrying it around.



With the keypad locked, you can still call the emergency services on 999 and 112 using preparatory dialling and you can still answer incoming calls and operate the in call features as normal. When the call is ended, the  comes on again.

If you get an incoming call or text message while you're paging a handset, the incoming call or message takes priority and paging will stop.

If the handset ringer is switched off on a handset, it will be temporarily switched back on so the handset can be found.



Paging calls can't be answered by a handset.

Turn the handset ringer on or off

1. Press and hold  for 2 seconds to turn the handset ringer on or off. The display will briefly show **Ringer on** or **off** before reverting to the idle screen with the  icon displayed if the ringer has been turned off.

Find handset (Paging)

You can ring a handset to help find it.

1. Press  on the base. All handsets registered to the base will ring and the screen will show **Base searching for handsets** for up to 2 minutes.
2. To stop the ringing, press  on the base again or press  on any handset.





Call control settings

Under the Call control menu are the features Do not disturb, Block Calls and Parental control. Do not disturb allows calls to be received silently with minimal notification.

Parental control allows you to control the type of outgoing calls that can be made. You can also assign VIPs in your contacts to whom outgoing calls can still be made even if Parental control is turned on and calls can be received from as normal even if Do not disturb is turned on.

To enter the Call control sub menu you need to enter your remote access PIN. This will need to be set the first time you try and enter the sub menu, simply follow the on screen instructions. If you have already changed the remote access PIN when setting your remote access then you will not need to set it again.

Set-up Do not disturb

1. Select **Menu**, scroll  to **Call Control** and press **Select**.
2. Enter the access PIN and select . **Incoming Calls** is displayed, press **Select**.
3. **Do Not Disturb** is highlighted, press **Select**.
4. Press  or  to select **On**, **Off** or **Timed**. If you select **Timed** you need to select the on and off times

When Do not disturb is set to On, the base and handset ringer volumes (on all handsets registered to the base) will be set to Off. The handset backlight will not come on when the phone rings and the only tones that the handset will emit are the battery low and out of range warnings. The base call screening volume and message alert will also be set to Off.

This remote access PIN is different to the system PIN. See page 55-56.

You can set Do not disturb to on, off or you can set specific times when the feature is on and off. The default setting is off.

When set to On, the idle screen will display **DO NOT DISTURB** instead of the handset name.

Please note, other products connected to the line are not compatible with this feature and will still ring.

For more information and general advice on handling unwanted calls please go to bt.com/unwantedcalls

You must subscribe to a Caller Display service from your network provider for the block nuisance calls feature to work. Charges may apply.

Blocked will be displayed with no backlight on the handset when a blocked call is received. The handset or base will not ring.

No PIN number is required when using the block call button when there is an incoming call or during a call.

you want, press **Calls** and enter the on time, then **Calls** again and enter the off time. Press **Calls** to highlight whether you want VIP calls to be **Allowed** or **Not Allowed** using **◀** or **▶**, then press **Save**. The chosen setting will be displayed and you will hear a confirmation tone.

Block nuisance calls

The BT6610 blocks numbers in two separate ways to help you avoid nuisance calls, firstly by type e.g withheld or international and also by your choice of specific numbers (you can store up to 100 numbers of your own choice).

1. Select **Menu**, scroll **Calls** to **Call Control** and press **Select**.
2. Follow the instructions to set your PIN for the first time and select **OK**, (see page 55).
3. **Incoming calls** is displayed, press **Select**.
4. Press **Calls** to highlight **Block calls** and press **Select**. You now have 2 choices:
 - i) To block calls by type, when **By call type** is highlighted, press **Select**. Select **Blocked** or **Allowed** for each of the call types by highlighting each one using **◀** and **▶**: **International**,



Withheld number, No Caller ID and Payphone, then select **Save**.

ii) To block calls by a specific number, press  to highlight **By number** and press **Select**. You've entered the blocked numbers list, press **Options** and select **Add**. Enter the number you want to block (or you can select **Options** and select a number from your contacts or calls list) then select **Save**.

The Block button

The block call button can be used in 3 ways:

1. Incoming call

When you have an incoming call, before pressing the  to answer, look at the handset display and you can see who is calling. If you don't want to take the call press the  on the handset and the call will be transferred to the answering machine for the caller to leave a message.

The number will be blocked and added to the blocked calls list if Caller ID is displayed. If the number calls again your phone will just ring silently and the caller cannot leave another message.

The default setting is Allowed for all call types.

If you select Allowed, calls from this type of number will ring as normal. If you select Blocked, calls from this type of number will be presented silently.

When you enter the block calls list you can also edit or delete numbers you've stored previously by selecting Options, then highlighting either Edit or delete and pressing Select.

If 'All dialled calls' is set to **Not Allowed**, this will take precedence over the other settings except emergency numbers 999 and 112 which can still be dialled.

If 'All dialled calls' is set to **Allowed**, the status of the other settings will manage which calls can be made. The default for all Parental control settings is **Allowed**.

If you listen to the caller's original message and decide that the caller is not a nuisance caller and you want to receive future calls from them, you can remove them from the blocked numbers list. Go to the **Call Control menu** and delete their number from the blocked list, you will need to enter your PIN to access the blocked number list (see page 55–56).



2. During a call

If you have already answered the call and you want to block the number press , if the number is displayed in the Caller ID, the display will give you the option to select **Yes** and the number will be added to the blocked numbers list and end the call, or select **No** to go back to the caller.



3. In idle mode

Press  as a shortcut to the Call Control menu (see page 28).

Set Parental control

1. Select **Menu**, scroll  to **Call Control** and select **Options**.
2. Enter the access PIN and select **OK**. Press  to highlight **Parental Control** and press **Select**.
3. **Mobile calls** is highlighted, press **<** or **>** to select **Allowed** or **Not Allowed**, then press  to highlight **International** and follow the same procedure for each option displayed and then select **Save**. The display will show **Parental control settings saved**. You will then be prompted to add some VIPs if you haven't already assigned any.

Assign VIPs

1. Select **Menu**, scroll  to **Call Control** and select **Options**.
2. Enter the access PIN and select **OK**. Press  to highlight **VIP list** and press **Select**.
3. Read the prompt and select **Info**, read the message and select **Yes**. Your contacts list will be displayed.
4. To assign contacts as VIP, highlight the contact and press **OK**. Select additional contacts if required by repeating above.

You will be unable to use **BT 118500** from special numbers when **Premium Rate** calls are set to '**Barred**'.

You can set whether calls from VIPs will still be allowed to ring or not when the Do not disturb feature is turned on. The default setting is Allowed.

If set to Not Allowed all calls will be presented silently. If set to Allowed Calls from VIPs will ring as normal.

If you've already added VIPs to your VIP list the list will be displayed when you enter the VIP list menu. You can then select **Options** to add further VIPs, remove VIPs or assign a VIP ringtone.

The same access PIN is used for remote access and call control.

5. Select **Options**, **Add selected** will be highlighted, select **OK** and the selected entries will be added to your VIP list.

Change the access PIN



1. Select **Menu**, scroll **Calls** to **Call Control** and press **Options**.
2. Enter the existing 4 digit remote access PIN. Press **Calls** to highlight **Change PIN** and press **Select**.
3. Once you've read the reminder message, select **OK** then enter the existing 4 digit access PIN and select **OK**.
4. Enter the new 4 digit access PIN and select **OK**, then enter it again when prompted and select **OK**. **Access PIN saved** will be displayed.

Contacts

You can store up to 200 entries in your list of contacts. For each contact you can save a home, mobile and work number. Contact entries will automatically be copied to any other handsets you have registered to the base. Any change made on one handset will be updated on all other handsets.

The handset will come with some special numbers pre-stored. These will include Your BT Product Helpline, BT 118500, All handsets (if you have more than two handsets registered) and a list of the handsets registered to the base according to their default name/number (e.g. Handset 2 or 3 etc) or name if you have stored one.



Store a contact

1. From the idle screen, press .
2. Select **Options**. **Add contact** is highlighted, press **Select**.
3. Enter the new contact name using the keypad (see note opposite for help) then press  and enter the home phone number. You can then press  and enter a mobile number and then a work number if you want to. Select **Save** when you've finished. The display will show **Contact saved**.

You must enter a name and at least one telephone number for the contact to be stored.

Names can be up to 25 characters and numbers up to 24 digits.

Entering names

Use the keypad letters to enter names, e.g. to store Tom: Press  once to enter T. Press  three times to enter o. Press  once to enter m.

Writing tips

To delete the last digit/character entered, select **Clear**.

Press  to switch between text entry modes: sentence case (Abc), upper case ABC, lower case (abc) or numeric (123).

Press  to insert a space.

To enter a pause in a contact number

When storing a number, press and hold  in the place where you want the pause.

To enter a recall in a contact number

When storing a number, press  in the place where you want the recall.





Searching alphabetically

You can alpha search for contact names by entering multiple characters, the search will be carried out on the beginning of the name only. e.g. enter Ja and names beginning with these two letters will be filtered. You can then scroll through the filtered list.







Character map

1	& . , ' ? ! @ 1
2	a b c 2 à á â ã ä æ ç
3	d e f 3 è é ê ë ì
4	g h i 4 î ï ð
5	j k l 5 £
6	m n o 6 ö ô ò ó õ ø ñ
7	p q r s 7 \$ %
8	t u v 8 ü ù ú û
9	w x y z 9
0	space 0 + £ \$ % *
*	*
#	Changes text entry mode (sentence case, upper, lower or numeric)



View/dial a contact

1. From the idle screen, press  to open your contact list.
2. Press  or  to scroll through and view the entries.
3. To dial an entry, press  when the entry is highlighted. If the entry has more than one number saved under it you will need to highlight the number you want and then press  again.

Edit a contact

1. From the idle screen, press .
2. Press  or  to scroll to the entry you want to edit and select **Options**.
3. Press  to highlight **Edit contact** and press **Select**.
4. Edit the name by pressing  or  button to move cursor left or right and **Clear** to delete characters and use the keypad to enter new ones, then press  to move the cursor to edit any of the numbers you have stored, using **Clear** to delete digits and re-enter any new ones, then select **Save**. The display will show **Contact saved**.

Delete selected or all contacts

1. From the idle screen, press , then select **Options**.
2. Press  until **Delete contact** is highlighted and press **Select**.

You cannot edit the special contact entries that the handset has pre-programmed in the memory.

When a contact is deleted it will also be deleted from the VIP call control list, see page 32.

You cannot delete the special contact entries that are pre-programmed in the contacts list.

You can also highlight **Clear selection** if you want to remove the ticks so the contacts are not marked for deletion anymore.

The delete all contacts feature will not delete the special contact entries that are pre-programmed in the contacts list.

3. You can now either:

Select which contact(s) to delete by scrolling to highlight the contact and pressing **OK**. A tick will mark the contact for deletion. Once all the contacts you want to delete have been marked, select **Options. Delete selected** will be highlighted, select **OK**, then select **Yes** to confirm.



Or, to delete all contacts, select **Options** and scroll **Calls** to highlight **Select all**, then select **OK** then **Yes** to confirm.

View the contact memory status



1. From the idle screen, press **CP**, then select **Options**.
2. Press **Calls** until **Memory status** is highlighted and press **Select**.
3. The display will show the percentage of the contact memory used, e.g. **35% Full**.

Speed dial

Save a Speed dial entry

1. From the idle screen, enter the telephone number you want to store.
2. Then, either:
 - Press and hold the Speed dial button **1** to **9** you want to store the number under.
 - Or,
 - Select **Options**, scroll  to highlight **Set speed dial** and press **Select**. Scroll  to the speed dial location number you want (1-9) and select **Save**. The display will show **Saved as speed dial x** (x being the Speed dial button).



Dial a Speed dial entry

1. Either, press and hold the Speed dial button **1** to **9** under which the entry you want to dial is stored. Or, Select **Menu**, scroll  to display **Speed Dial List** and press **Select**. Scroll  to highlight the entry you want then press . The number will be dialled automatically.





You can allocate a name and number to each of the Speed dial buttons **1** to **9**. Button **1** is pre-programmed with 1571 but you can delete this and replace it with an entry of your choice. Once a Speed dial entry has been stored you can simply press and hold the Speed dial button to automatically dial the number stored under it (names are only shown if taken directly from the contact list).

If you try to save a Speed dial entry under a Speed dial button that has already been populated, the display will show **Replace existing number?** and you will hear an error tone. You can either overwrite the existing entry by selecting **Yes** or you can press and hold a different Speed dial button or select **No**.

Edit a Speed dial entry

1. Select **Menu**, scroll  to display **Speed Dial List** and press **Select**.
2. Press  or  to highlight the entry you want to edit and select **Options**.
3. **Edit** is highlighted, press **Select**.
4. Edit the number by selecting **Clear** to delete digits and then enter any new digits. Select **Save**. **Saved as speed dial x** will be displayed.

Delete a Speed dial entry

1. Select **Menu**, scroll  to display **Speed Dial List** and press **Select**.
2. Press  or  to highlight the entry you want to delete and select **Options**.
3. Scroll  to highlight **Delete** and press **Select**.
4. **Delete speed dial x?** is displayed, select **Yes**. **Speed dial x deleted** will be displayed.

Caller Display and the Calls list

Caller Display

If you've subscribed to a Caller Display service, you'll be able to see your caller's number on your handset display (provided it's not withheld) before you answer a call. If your caller's name is stored in your contacts list and it matches the number calling, you'll see the caller's name and where they are calling from (i.e. Home, Mobile or Work) on the display instead. If you haven't subscribed to a Caller Display service **Incoming call** will be displayed when you receive a call. If you receive a call from a number you have stored in your Blocked calls list **Blocked** will be displayed under the name or number.

Calls list

The Calls list holds up to 50 incoming (missed and answered) calls and 30 outgoing calls. The date and time of the call is also stored. If you haven't subscribed to a Caller Display service, **No number** will be displayed in the Calls list for incoming calls but the time and date will still be recorded.

Calls are listed in chronological order with the most recently received/made call at the top of the list.

You'll need to subscribe to your network provider's Caller Display service for this feature to work. You might have to pay a fee. For more information on BT Calling Features, call BT free on 0800 800 150.

To make sure the caller's name is displayed, make sure you've stored the full telephone number in your contacts list, including the dialling code. You can store more than one number for the same caller.

There are some incoming calls where a number is not displayed and a network message is recorded instead:

Unavailable = number is unavailable

Withheld = number has been withheld

International = international number

Operator = call from the operator

Payphone = call from a payphone

Ringback = a ringback call

41 Caller Display and the Calls list

Calls list indicators



= outgoing call made



= incoming call received



= missed call



= caller left a voice message

When the Calls list is open, press to scroll from the newest call to the oldest, or press to scroll from the oldest call to the newest.

If you only want to view the missed calls list, from the idle screen when the is displayed press . The missed calls list will be displayed and you can view and access the same options as described for the complete calls list.

When the list is full and a new call is received/made, the oldest entry will be deleted automatically. The Calls list can hold numbers up to 24 digits and names up to 25 characters.

Missed call notification

If an incoming call has been missed (i.e. not answered), the missed call icon will be displayed on the idle screen with the number of missed calls displayed underneath it e.g. 1. You can clear the notification by viewing the calls list on any handset registered to the base. The icon will still be presented for missed calls in the calls list so you can differentiate between calls. See Calls list indicators opposite.

View and access options in the Calls list

1. Press or select **Calls**. The most recent entry is at the top of the list. (If there are no entries **List empty** will be displayed.)
2. Press or to scroll through and view the list.
3. To dial an entry, when the entry you want is highlighted, press .

To play an answer message, when the entry you want is highlighted, select **Options**, **Play message** is highlighted, press **Select**. The message will be played.

To send a text message to the caller, when the entry you want is highlighted, select **Options**, scroll  to **Send text**, press **Select** and follow the instructions to send a text as detailed on page 69.



To block the number, when the entry you want is highlighted, either press  or, select **Options**, scroll  to **Block number** and press **Select**.

If you haven't set up your access PIN yet, you will be prompted to follow the instructions.

If the access PIN has been set you will be prompted to enter the 4 digit PIN, then select **OK**.

The number you selected to block is highlighted, select **Save**. **Blocked number saved** will be displayed.

Save a Calls list entry to your contacts

1. Press  or select **Calls**, then press  or  to highlight the entry you want and select **Options**.
2. Highlight **Save number** and press **Select**.
3. You now have two options:

For more information and general advice on handling unwanted calls please go to bt.com/unwantedcalls

For further instructions on call blocking see page 29.

If you have more than one handset registered to the base, all data is synchronised across handsets. Therefore, if you save a calls list entry to your contacts it will be saved on all handsets.

43 Caller Display and the Calls list

If you need to edit the name, press the **◀** or **▶** button to move the cursor left or right and use Clear to delete unwanted characters then use the keypad to enter new ones.

You can replace an existing number if you want to.

If you have more than one handset registered to the base, data is synchronised across all handsets. Therefore, if you delete a calls list entry on one handset it will be deleted on all handsets.

- i) To save this as a new contact, highlight **New contact** and press **Select**. Highlight the type of number, then press **Select**. Enter the contact name and select **Save**.
- ii) To add to an existing contact, highlight **Add to contact** and press **Select**. Scroll to highlight the entry you want and press **Select**. Highlight the number type where you want to save the number (Home, Work or Mobile) and press **Select**.

Delete an entry in or the entire Calls list

1. Press **Calls** or select **Calls**, then if you want to delete just one entry, press **Volume** or **Calls** to highlight the entry and select **Options**. To delete the entire list, simply select **Options**.
2. Press **Calls** to display either **Delete call** or **Delete all** and press **Select**. **Call deleted** will be displayed if you have deleted one entry, if you chose to delete all then you will need to confirm by selecting **Yes**.







Answer machine

Your BT6610 can digitally record up to 30 minutes of messages. You can operate your answer machine from: the handset, the base (see page 53) or remotely from any other Touchtone™ telephone (see page 55).

If you receive a call from a number you have stored in your Blocked calls list, the caller will not be able to leave an answer phone message.

Using the answer machine from the handset

Switch the answer machine on or off and set the answer mode

1. Select **Menu**, **Answer Phone** is displayed, press **Select**.
2. Press  until **Answer mode** is highlighted, press **Select**.
3. Press  or  to select **On** or **Off** then scroll  to set the answer mode, press  or  to highlight **Ans. & Rec** or **Answer only** and then select **Save**. **Answer mode saved** will be displayed and the current answer mode will be announced.

You'll need to set the date and time (if you've not already done so during set-up) so that the answer machine can correctly announce when each message was received. To set the date and time manually, see page 65.

When the answer machine is switched on, the text **On** will light up on the  button.

The default answer mode is **Answer & Record** using the female voice.

Answer & Record

The pre-recorded Answer & Record outgoing message that allows your caller to leave a message is, “Hello, your call cannot be taken at the moment, so please leave your message after the tone”.

Answer Only

The pre-record Answer Only outgoing message, where callers hear an announcement but can't leave a message, is “Hello, your call cannot be taken at the moment and you cannot leave a message, so please call later”.

When recording your Answer Only message, remember to let your caller know that they won't be able to leave a message.



The default outgoing message mode is Answer & Record using the female voice.

If your answer machine is full you will not be able to record your outgoing message.





Outgoing messages

The outgoing message is the message a caller first hears when the answer machine picks up their call. There are two pre-recorded male and female outgoing messages to choose from, one that allows callers to leave a message (Answer & Record) and one that simply answers the call (Answer Only) or you can record your own.



Record your own outgoing message

1. Select **Menu**, **Answer Phone** is displayed, press **Select**.
2. Press  until **Outgoing msg** is displayed, press **Select**.
3. Press  or  to highlight the outgoing message mode you want: **Ans. & record** or **Answer only** and press **Select**.
4. **Record message** is highlighted, press **Select**. Follow the voice prompt to record your message and select **Save** when you've finished.
5. Your message will be played back to you. Select **OK** if you're happy with it or you can delete it by selecting **Delete**.

Play the current outgoing message

1. Select **Menu, Answer Phone** is displayed, press **Select**.
2. Press  until **Outgoing msg** is displayed, press **Select**.
3. Press  or  to highlight the outgoing message mode you want: **Ans. & record** or **Answer only** and press **Select**.
4. Press  to highlight **Play message** and press **Select** to hear the outgoing message. If the current outgoing message being played is your recorded message you can delete it if you want to by selecting **Delete**.

Reinstate the pre-recorded outgoing message

1. Select **Menu, Answer Phone** is displayed, press **Select**.
2. Press  until **Outgoing msg** is displayed, press **Select**.
3. Press  or  to highlight the outgoing message mode you want: **Ans. & record** or **Answer only** and press **Select**.

Reinstating the pre-recorded outgoing message will not delete your recorded outgoing message. It will be retained in case you want to use it in the future.

You can record a memo message on the answer machine for other users to hear when they listen to messages. You can only record memos using the handset. Memo messages are played back in exactly the same way as normal answer machine messages, see page 50 and 54.

4. Press **Calls** to highlight **Use default msg** and press **Select**.
5. Press **<** or **>** to display **On**. Scroll **Calls** and then use **<** or **>** to display either **Female** or **Male** and select **Save**. **Saved** will be displayed.





Record a memo

1. Select **Menu**, **Answer Phone** is displayed, press **Select**.
2. Press **Calls** until **Record memo** is displayed, press **Select**.
3. Follow the voice prompt to record your memo and select **Save** when you've finished.
4. Your memo will be played back to you. Select **OK** if you're happy with it or you can delete it by selecting **Delete**.

Answer delay





The answer delay setting sets how many times the phone will ring before the answer machine takes the call. You can choose from 2–10 rings or Time saver. The default setting is 4 rings.

Set the answer delay

1. Select **Menu, Answer Phone** is displayed, press **Select**.
2. Press  until **Settings** is displayed, press **Select**.
3. Press  to highlight either **Ans. & record** or **Answer only** and press **Select**.
4. **Answer delay** is displayed, use  or  to display the number of rings you want (2–10 rings or Time saver) and select **Save**. **Saved** will be displayed.

Set the maximum message length

You can set the maximum length that an answer machine message can be: 1 minute, 2 minutes or 3 minutes. The default setting is 3 minutes.

1. Select **Menu, Answer Phone** is displayed, press **Select**.
2. Press  until **Settings** is displayed, press **Select**.
3. Press  to highlight **Ans. & record** and press **Select**.
4. Press  to display **Max. msg length** and then press  or  to select the length you want and select **Save**. **Saved** will be displayed.

Time saver

When you ring in to access your answer machine remotely, if you have set Time saver as the answer delay and you have new messages it will answer after 2 rings. If you don't have new messages it will answer after 6 rings. This means you can hang up knowing that you have no new messages, saving you the time and the cost of the call.

For compatibility with BT 1571 (or another voicemail service)





Make sure the answer delay is set for your answer machine to answer before the voicemail service. Therefore, the answer delay should be less than on your voicemail service. For BT 1571 do not set the answer delay to more than 5 rings.

When the message alert is set to On, the base will beep at regular intervals. The default setting is On.

The default setting is call screening Off.

When Auto-answer is set to ON (see page 61) and Call Screening is set to OFF, you can intercept the caller leaving a message by picking up the phone from the base without the need to press any keys.





Set the message alert on or off

1. Select **Menu, Answer Phone** is displayed, press **Select**.
2. Press  until **Settings** is displayed, press **Select**.
3. Press  to highlight **Ans. & record** and press **Select**.
4. Press  to display **Message alert** and then press  or  to select **On** or **Off** and select **Save**. **Saved** will be displayed.

Call screening via the handset

When call screening is turned on and the answer machine takes a call, you can listen to the caller leaving a message. You can then identify the caller and decide whether to take the call in person.

Turn call screening on or off





1. Select **Menu, Answer Phone** is displayed, press **Select**.
2. Press  until **Settings** is displayed, press **Select**.
3. Press  to highlight **Call screening on/off** press **Select**.
4. Press  or  to display **On** or **Off** and select **Save**. **Saved** will be displayed.





Using call screening



When the phone rings, wait for the answer machine to take the call. When the caller begins to leave a message, the display will show **Leaving a message**, underneath the callers number (or name if you have added as a contact and a caller display service).

If you wish to listen to the message being recorded, press the left option key to select **Listen** or, if you wish to talk to the caller, press  to take the call. Talking to the caller will stop the recording if it's started.

Message playback using the handset

1. Highlight the answer phone icon on the idle screen and press , or
 - i. Select **Menu, Answer Phone** is displayed, press **Select**.
 - ii. **View Messages** will be displayed, press **Select**.
2. A list of your answer phone messages will be displayed with the most recently received highlighted at the top.
3. Use  or  to scroll through the list to highlight the message you wish to listen to and press .
 - i. If you have more than one message stored and want to listen to them all, select **Options**. **Play all** will be highlighted, press **Select**.

While screening, you can adjust the volume by pressing  or  on the handset or  or  on the base.

When you receive new messages you'll be notified by an answer phone icon displayed on the idle screen with the number of messages displayed underneath it e.g.  and the  button on the base will flash. The number of messages displayed includes all messages stored, new and old (played). When a message is deleted the counter will be updated accordingly. You can also set an audible alert, see page 49.

Each message is played back with the day, date and time it was received announced.

51 Answer machine

New (unplayed) messages are played first (oldest to most recent) and then old (played) messages (oldest to most recent).

If the memory is full, the answer phone icon on the idle screen will display **Full** underneath it. You can still enter the answer phone menu and playback your messages, however, you will see a warning message **Memory full**. **No messages can be left** before you enter the menu and **Memory full** will be announced before new or old messages are played back.

Message playback is stopped if you receive an incoming call.

You can toggle between private playback through the handset and handsfree playback by pressing the  button. The default is private playback.



Unless you delete a message, it's automatically saved.



4. As each message is played, the handset will display the number or the name if you have Caller Display and a name/number match and the time and date it was received. If you have any old (already listened to) messages these will be played after your new messages.

During playback you have the following options:

 or  to adjust the playback volume.

 to switch private playback through the handset to handsfree playback.

 or  once to repeat the current message playing from the beginning.

 or  twice within a second to skip back to the previous message.

 or  once to skip forward to the next message.

Delete or  to delete the current message playing.

At the end of playback, you will hear, “End of messages,” and the same message will be displayed. The answer phone icon on the idle screen will be renumbered to take into account any deleted messages.

Delete a message or delete all old (played) messages

1. Select **Menu, Answer Phone** is displayed, press **Select**.
2. **View Messages** will be displayed, press **Select**. A list of your answer phone messages will be displayed.
3. Select **Options** and scroll  to highlight either **Delete message** or **Delete all old msgs** and press **Select**.
4. A confirmation question will be displayed, select **Yes** to confirm deletion.

Save a number in the answer phone message list to your contacts

1. Select **Menu, Answer Phone** is displayed, press **Select**.
2. **View Messages** will be displayed, press **Select**. Highlight the number you want to save and select **Options**.
3. Scroll  to highlight **Save number** and press **Select**.
4. You now have two options:
 - i) To save this as a new contact, highlight **New contact** and press **Select**. Highlight the type of number, then press **Select**. Enter the contact name and select **Save**.

To cancel deletion, when you see the confirmation question, select **No**.

ii) To add to an existing contact, highlight **Add to contact** and press **Select**. Scroll to highlight the entry you want and press **Select**. Highlight the number type where you want to save the number (Home, Work or Mobile) and press **Select**.

Send a text to a number in the answer phone message list

1. Select **Menu, Answer Phone** is displayed, press **Select**.
2. **View Messages** will be displayed, press **Select**. Highlight the number you want to send to and select **Options**.
3. Scroll  to highlight **Send text** and press **Select**.
4. Enter and send your text message as per the instructions detailed on page 70.

Using the answer machine from the base

Switch the answer machine on or off

Press  to toggle between **On** and **Off**. The setting is announced.

When the answer machine is switched On, the text 'On' will light up on the  button.

Message playback using the base

Press . If you have messages they will be played, new (unplayed) messages first followed by old (played) messages.

During playback:



Press  to stop playback. The base will return to idle.

Press  to delete the message being played.

Press  to skip forward to the start of the next message.

Press  to skip back to the start of the current message.

Press  twice to skip back to the start of the previous message.

Press  or  to increase or decrease the playback volume level.

At the end of playback the base will return to idle mode and messages will be renumbered to take into account any deleted messages.

Memory full

If there is only 10 seconds of memory capacity left when a caller is leaving a message they will hear, "Please complete your message within 10 seconds." If a caller is still leaving a message when the memory expires they will hear, "Memory full. Thank you for calling", and the call will be ended.



If your answer machine memory becomes full and it is set to Answer and record it will automatically switch to Answer only mode. Once messages have been deleted and there is memory available again, the machine will revert to Answer and record mode (unless you have changed the mode yourself to Answer only using the handset menu).

You will need to delete messages before your answer machine will be able to record new ones. To delete old (played) messages, see page 52 and 55.

If you don't press  within 3 seconds you will hear, "Messages saved".

The Remote access PIN is also used for the Call control PIN.



Delete all old (played) messages

1. In idle mode, press . The base will announce, "To delete all old messages, press Delete", press  again within 3 seconds to delete all old messages. You will hear, "All old messages deleted."



Remote access

With remote access you can operate your answer machine from any Touchtone™ phone, even if you forget to turn on your answer machine before you go out. You need to set a remote access PIN first and then you will need to turn remote access On if you want to use this feature.



Set the remote access PIN for the first time

1. Select **Menu, Answer Phone** is displayed, press **Select**.
2. Press  until **Settings** is displayed, press **Select**.
3. Press  to highlight **Remote access** and press **Select**.
4. Read the message prompt, press  to read it all, then select **Set PIN**.
5. Enter a 4 digit PIN of your choice and select **OK**.
6. Enter the 4 digit PIN again to confirm and select **OK**. The display will show **Access PIN saved**.

Change the remote access PIN

1. Select **Menu, Answer Phone** is displayed, press **Select**.
2. Press  until **Settings** is displayed, press **Select**.
3. Press  to highlight **Remote access** and press **Select**.
4. Press  to highlight **Change PIN** and press **Select**. You will be reminded that the access PIN is used for both remote access and call control.
5. Enter your old 4 digit PIN and select **OK**.
6. Enter the new 4 digit PIN, select **OK**, then enter the new PIN again and select **OK**. The display will show **New Access PIN saved**.

Turn remote access on or off

1. Select **Menu, Answer Phone** is displayed, press **Select**.
2. Press  until **Settings** is displayed, press **Select**.
3. Press  to highlight **Remote access** and press **Select**.
4. **On/Off** is displayed, press **Select**.

Select **Clear** if you need to delete any digits.

The Remote Access PIN is also used for the Call Control PIN.

You cannot turn Remote access On until you have set a remote access PIN.

The default setting is Off.

Remote Access must first be enabled to allow you to switch on the answer machine remotely.

5. Press **←** or **→** to display **On** or **Off** and select **Save**. **Saved** will be displayed.

If you forget to switch on your answer machine

1. Call your number from another phone and let it ring. After 20 rings the machine will switch on and answer your call.
2. Press ***** and enter your 4 digit remote access PIN when prompted. Play back your messages as shown on page 58 in, 'Operating your answer machine remotely'. If you do not choose to switch your answer machine On, it will switch off when the call is ended.

Operating you answer machine remotely

1. Dial your phone number.
2. When you hear your outgoing message, press * and enter your 4 digit remote access PIN.
3. Follow the voice prompts to:
 - 1 To replay the current message
 - 2 To play all messages
 - 3 To delete during messages
 - 4 To skip back during messages
 - 5 To set Answer machine OFF, or ON
 - 6 To skip forward during messages
 - 7 Turn Text Alert OFF, or ON
 - 8 To play your outgoing message
 - 9 To record a new outgoing message
 - # To set to Answer Only, or Answer & Record
 - 0 To hear the main menu options

Settings

Choose from 15 handset ringtones. The default external ringtone is Melody 1 and the internal ringtone is Melody 2.





There are 5 handset ringer volume levels plus Ringer Off. The default setting is Level 3. If you turn the ringer off, the  icon will be displayed on the idle screen.

As a quick way to turn the handset ringer off, press and hold .





There are two alert tones: voice message (answer phone) and text message tones. You can turn these on or off, the default setting is On. When the voice message alert is set to On, the base will beep at regular intervals when you receive an answer phone message. When the text message alert is set to On, the handset will beep at regular intervals when you receive a text message.

Handset settings





Set the handset ringtone for external or internal calls and the ringer volume

1. Select **Menu**, scroll  to display **Settings** and press **Select**.
2. **Sounds** is highlighted, press **Select**. **Ringing** is highlighted, press **Select**.
3. Press  or  to highlight the external melody you want, then press  to select the internal melody you want from the 15 ringtones.
4. Press  again to select the volume level you want and select **Save** to save your choices.





Turn the alert tones on or off

1. Select **Menu**, scroll  to display **Settings** and press **Select**.
2. **Sounds** is highlighted, press **Select**. Press  to highlight **Alert tones** and press **Select**.
3. Press  or  to highlight **On** or **Off** for the Voice message alert and then press  to highlight **On** or **Off** for the Text message alert and select **Save**.



Turn the handset tones on or off

1. Select **Menu**, scroll  to display **Settings** and press **Select**.
2. **Sounds** is highlighted, press **Select**. Press  to highlight **Handset Tones** and press **Select**.
3. Press  or  to highlight **On** or **Off** for Keypad tones and then press  to highlight **On** or **Off** for **Confirmation tones** and select **Save**.

Change the handset display contrast

1. Select **Menu**, scroll  to display **Settings** and press **Select**.
2. Press  to highlight **Display** and press **Select**.
3. Press  or  to select the level you want, then select **Save**.

Change the handset name

1. Select **Menu**, scroll  to display **Settings** and press **Select**.
2. Press  to highlight **Handset name** and press **Select**.
3. Edit the name by selecting **Clear** to delete the characters, then enter the new name and select **Save**.

There are two handset tones: keypad tones and confirmation tones. You can turn these on or off, the default setting is On. Keypad tones: when turned on, you will hear a beep after each button press.

Confirmation tones: when turned on, you will hear a tone after each successful action or after an error has occurred. This does not include the battery charging tone when the handset is placed on the base/charger, low battery or out of range warnings or tones used in calls such as Call Waiting or Call Intercept.

There are 5 contrast levels to choose from. The default setting is Level 3.

A handset name can be a maximum of 12 characters. If you name your handset, the handset number will be removed, e.g. instead of saying **Kitchen 1** the name would just be **Kitchen**. To revert back to the default handset name (Handset x), delete all the characters and select **Save**.

61 Settings

The default setting is Auto answer Off to help with managing any nuisance calls.

If Auto answer is set to On you can answer a call by lifting the handset off the base. If it's set to Off, you'll need to lift the handset off the base and then press .





If Auto end is set to On you can end a call by placing the handset back in the base.

If Auto end is set to Off, you'll need to press  to end the call.

With Auto join calls set to On you can automatically join an existing call from another registered handset without being invited to join the call, you can simply press  to join.

With First ring set to Off, an incoming external call will be displayed visually before the handset(s) start to ring for the second burst of ringing.





Change the call settings (Auto answer, Auto end call, Auto join and First ring)

1. Select **Menu**, scroll  to display **Settings** and press **Select**.
2. Press  to highlight **Call settings** and press **Select**.
3. Press  or  to highlight **On** or **Off** for Auto answer and then press  to highlight **On** or **Off** for Auto end call, follow the same procedure for Auto join calls and First ring, then select **Save**.

Base settings

Set the base ringtone melody and volume



Choose from 5 base ringtones. The default is Melody 1. There are 5 base ringer volume levels plus Ringer Off. The default is Level 3.

1. Select **Menu**, scroll  to display **Settings** and press **Select**.
2. Press  to highlight **Base settings** and press **Select**.
3. **Ringtone** is highlighted, press **Select**.
4. Press  or  to highlight the ringtone melody you want, then press  to select the volume level you want and select **Save** to save your choices.



PBX access code

If you're connected to a switchboard, you might need to enter an access code (e.g.9) before each number is dialled. Your BT6610 can store an access code which is automatically dialled before each number.

Set a PBX access code

1. Select **Menu**, scroll  to display **Settings** and press **Select**.
2. Press  to highlight **Base settings** and press **Select**.
3. Press  to display **PBX Code** and press **Select**.
4. Enter the number you want (maximum of 4 digits) and select **Save**.

Change the system PIN

1. Select **Menu**, scroll  to display **Settings** and press **Select**.
2. Press  to highlight **Change Sys. PIN** and press **Select**.
3. If the current PIN is 0000, you will be prompted to enter the new 4 digit PIN, then press **OK**. (Or, if the current PIN is not 0000, you will be prompted

If you wish to revert to not using a PBX access code, you need to go into the PBX code menu and delete all the digits by selecting **Clear**, then select **Save**.

The default system PIN is 0000. You can change this to your own preferred 4-digit code.

The system PIN is different to the call control PIN. See page 33.

The system PIN is used when changing certain settings and for registration/de-registration.

If you make a mistake, select **Clear** to delete a digit.

If you reset the handset settings all the handset settings will return to their default settings, e.g. the handset name, ringer melody, all volume levels, display and alarm settings.

If you reset the base settings all the base settings will return to their default settings, e.g. the base ringer melody, all volume levels, PBX access codes and answer machine settings.





The default setting is Eco mode Off.

to enter the old (current) 4 digit PIN first and then select **OK**. Then follow the prompts and enter the new 4 digit PIN).

4. Enter the new 4 digit PIN again and select **OK**. The display will show **New system PIN saved**.

Turn Eco mode on or off

With Eco mode on, the handset only uses the transmission power it needs to communicate with the base rather than full transmission power all the time.



1. Select **Menu**, scroll  to display **Settings** and press **Select**.
2. Press  to highlight **Auto-ECO** and press **Select**.
3. Press  or  to highlight **On** or **Off** for Auto answer and then press  to highlight **On** or **Off** and select **Save**.

Reset the handset or base settings

1. Select **Menu**, scroll  to display **Settings** and press **Select**.
2. Press  to highlight **Reset** and press **Select**.

3. **H/set settings** is highlighted, press **Select** or press  to highlight **Base settings** and then press **Select**.
4. **Reset <handset or base> settings back to default?** is displayed, select **Yes**.
5. **Resetting <handset or base> settings...** is displayed while the reset takes place. Once finished, **<handset or base> settings reset back to default** is displayed.

Clear the handset and base user data

1. Select **Menu**, scroll  to display **Settings** and press **Select**.
2. Press  to highlight **Reset** and press **Select**.
3. Press  to highlight **Clear user data** and press **Select**.
4. If the current system PIN is not 0000 you will be prompted to enter the PIN then press **OK**. If it is 0000, you will continue straight to step 5.
5. **Delete data on all handsets and base?** is displayed, select **Yes**.
6. **Deleting all user data...** is displayed. Once finished, **All user data deleted** is displayed.

If you clear the handset and base user data all your contacts and the calls list will be deleted and your recorded outgoing messages and all received answer machine messages will be deleted.

Clock/Alarm

You must enter the full date: day, month and year.







You must enter both time and date otherwise nothing will be saved.

The default time format is 12 hour.





If you didn't set the time and date when you first set-up your phone then you will need to do so before you can set an alarm. The clock will also be displayed on the handset screen in idle mode.

If you have subscribed to a Caller Display service the time and month will be set when you receive your first call but you will still need to set the year.





Set the time and date

1. Select **Menu**, scroll  to display **Clock/Alarm** and press **Select**.
2. Press  to highlight **Time and date** and press **Select**.
3. Use the keypad to enter the digits for the time.
4. Press  then  or  to select **AM** or **PM**, then press  again and enter the date. Select **Save**.

Set the time format (12 or 24 hour)

1. Select **Menu**, scroll  to display **Clock/Alarm** and press **Select**.
2. Press  to highlight **Time format** and press **Select**.
3. Press  or  to display **12 hours** or **24 hours** and press **Save**.

Set an alarm

1. Select **Menu**, scroll  to display **Clock/Alarm** and press **Select**.
2. **Alarm** is highlighted, press **Select**.
3. Press  or  to display the alarm frequency you want: **Off**, **On once**, **On daily**, **Mon to Fri** or **Sat & Sun** then press  and enter the alarm time, (you will also need to select AM or PM if you have set 12 hour format), then press  and to select the melody you want. Select **Save**.

Stopping the alarm when it goes off

When the alarm goes off, the selected melody will play at an ascending volume, the handset backlight will flash and the display will show the alarm time. The alarm will sound for 30 seconds and then the handset will return to idle, if the alarm isn't stopped or set to snooze, it will sound once more after 1 minute.

To stop the alarm, press  or select **Stop**.

To activate a ten minute snooze, select **Snooze** or any other button (except  or **Stop**). You can set snooze as many times as you want until you select **Stop**.

If you select Off the display will show Alarm off and you will hear a confirmation tone.

If you set an alarm the display will show the time and frequency setting after you select **Save**.

When you've set an alarm, the  icon will appear on the idle screen to confirm an alarm has been set.

If an incoming call is received while the alarm is going off, the alarm notification will immediately stop and the incoming call will be shown on the display. The alarm will not resume.

BT Calling Features

You need to subscribe to the specific BT Calling Feature to be able to use some of these services. You might have to pay a fee.

For more details on BT's Calling Features, go to bt.com/callingfeatures, refer to the user guide supplied when you subscribed to the services of your choice or call BT free on 0800 800 150.

If you're not connected to the BT network, some of these features may not be available. Call diversion services might allow other divert options. Please contact your telephone network provider for details.

Call Diversion will divert incoming calls to another number of your choice. You can choose all calls to be diverted or calls only to be diverted when the line is busy or only calls that are not answered.

You can easily access a number of BT Calling Features using the Calling Features menu.







Pre-stored numbers in the Calling Features menu

Call Diversion



Ringback

Call Waiting





Using Call Diversion: set up, cancel or check status

1. Select **Menu**, scroll  to display **Calling Features** and press **Select**.
2. **Call Diversion** is highlighted, press **Select**.
3. Press  or  to highlight the diversion option you want: **All Calls**, **When busy** or **Not answered** and press **Select**.
4. Press  or  to display either: **Set up**, **Cancel** or **Check status** and press **Select**.
5. If you selected **Set up**, you will need to enter the telephone number to divert to (or press  and select the number from your contacts), then select **Set up**. If you chose **Cancel** or **Check status**, the service will be called, follow the spoken instructions or listen for confirmation/status.

Cancel Ringback

1. Select **Menu**, scroll  to display **Calling Features** and press **Select**.
2. Press  to highlight **Cancel Ringback** press **Select**.
3. The service will be called and the display will show **Cancelling**. Follow the spoken instructions or listen for confirmation/status.

Using Call Waiting

1. Select **Menu**, scroll  to display **Calling Features** and press **Select**.
2. Press  until **Call Waiting** is highlighted, press **Select**.
3. Press  or  to highlight either **Turn On**, **Turn Off** or **Check status** and press **Select**. The service will be called. Follow the spoken instructions or listen for confirmation/status.

With the ring back feature you can get an automatic call back from an engaged number. No need to dial a busy number over and over again. Just dial 5, wait for a confirmation message and hang up. Your phone will keep trying the busy number for up to 45 minutes.

Call Waiting lets you know if another person is trying to call you while you're on another call. If a second caller rings, you will hear a beep in the handset earpiece. If you've subscribed to Caller Display, the display will show the caller's details as well.

Text messaging

IMPORTANT

You must subscribe to your network provider's Caller Display service to use text messaging and you must not withhold your telephone number. A fee may be payable, please contact your network provider for more details.

You may also send messages to landline phones that are NOT text compatible. Messages to non-compatible lines will be delivered in spoken words to the telephone as a call. Please note that the conversion can translate common abbreviations and smileys etc, but to ensure maximum clarity of message delivery, abbreviations should be used sparingly.

Your BT6610 can send and receive text messages from participating networks and compatible landline telephones in the UK. The fixed line text service is provided under BT's terms and conditions for telephone service. These can be found by visiting the bt.com website at <http://www.bt.com/terms>. There is no subscription charge (other than the subscription to Caller Display). Visit **bt.com** to find out how much it costs to send a text message, the cost will depend on your call package.



All messages in the inbox and sent folders are synchronised across all handsets registered to the base. Additions and deletions made on one handset are synchronised across all registered handsets. Draft messages remain local to each handset.

Register to the text messaging service





You need to register for the text messaging service under the text messages menu to use this feature.

You can register following these instructions:

1. Select **Menu**, scroll  to display **Text messages** and press **Select**.

2. Press  until **Settings** is highlighted, press **Select**.
3. Press  until **Re-register** is highlighted, press **Select**. **Re-register to receive text messages** is displayed, select **Send**. A text message containing the word 'Register' will be sent to the number 00000 and you will receive a confirmation message in return.

Send a text message

1. Select **Menu**, scroll  to display **Text messages** and press **Select**.
2. **Write message** is highlighted, press **Select**.
3. Use the keypad to enter your message.
4. Select **Options**. **Send to** will be highlighted:
To send the message, press **Select** and enter the telephone number (or press , select a number from your contacts and press **Select**) then select **Send**.
To save the message in the drafts folder, scroll  to highlight **Save** and press **Select**.
To insert a symbol in your message, press the  button then use the navigation buttons to highlight the symbol you want then select **Use**.

The sent and drafts folders are populated on a first in, first out basis. Once the folder is full, when a new message is added to the folder the oldest message will automatically be deleted.

If you receive a call while writing a text your text message will automatically be saved in the drafts folder when you answer the call.

You can also insert a symbol by scrolling  to highlight **Insert Symbol** and pressing **Select**.

71 Text messaging

There are 5 templates:

Please call home

I'll be there at

What time will you be home?

I'll call you back

Happy Birthday!





To insert a template, scroll  to highlight **Insert template** and press **Select**. Scroll to highlight the template you want then select **Use**.

To delete the message, scroll  to highlight **Delete message** and press **Select**. **Delete message?** will be displayed select **Yes**.

Receiving text messages

When you receive a text message the new message alert will sound (unless you've turned the alert off or you are using another audio feature like playing answer phone messages) and the new message alert screen will be presented for 4 seconds over the idle screen. The total number of messages received will be displayed on the screen e.g. for two messages the  icon is displayed with the number of text messages received underneath it.

Reading messages

1. From the alert screen, select **Read** or from the idle screen, highlight the  icon then press **OK**.
2. A list of your received text messages will be displayed. To read a message, highlight it, then press **OK**, you can use  or  to scroll through the message if necessary.
3. You can then press **Back** to return to the message list to read other messages or select **Options** and scroll  or  to highlight one of the following:

Delete message Press **Select**. **Delete message?** will be displayed, select **Yes** (or **No**) to cancel.

Reply Press **Select**. Enter your message using the keypad, then select **Options**. **Send to** will be highlighted, press **Select**. The telephone number (or name) will be displayed, press **Send**.

Forward Press **Select**. The message will be displayed, select **Options**. **Send to** will be highlighted, press **Select**. Enter the telephone number (or press , select a number from your contacts and press **Select**) then select **Send**.

If the Inbox is full you will see a warning message letting you know that no new text messages can be received until you delete some old messages, select **OK** to read your messages.

In the Inbox, unread messages are marked with the • icon. Once read, the icon will be removed.

Save number Press **Select**. You now have two options:

- i) To save this as a new contact, highlight **New contact** and press **Select**. Highlight the type of number, then press **Select**. Enter the contact name and select **Save**.
- ii) To add to an existing contact, highlight **Add to contact** and press **Select**. Scroll to highlight the entry you want and press **Select**. Highlight the number type where you want to save the number (Home, Work or Mobile) and press **Select**.

Delete msgs. Press **Select**. You now have two options: i) To select certain messages to delete, you need to highlight each message in turn and press **OK** to select the message for deletion – a ✓ in the box indicates it has been selected, then select **Options**. **Delete selected** will be displayed, select **OK**, then select **Yes**. ii) To delete all messages, press **Options**, scroll  to highlight **Select all** and select **OK**.

Accessing the Inbox, Drafts folder or Sent folder

1. Select **Menu**, scroll  to display **Text messages** and press **Select**.

2. Press **Calls** to highlight either **Inbox**, **Drafts** or **Sent** folder, then press **Select**.
3. A list of the messages will be displayed, press **Volume** or **Calls** to scroll through the list. You can press **OK** to read a highlighted message or select **Options** to access the list of menu options.

Edit a template

1. Select **Menu**, scroll **Calls** to display **Text messages** and press **Select**.
2. Press **Calls** until **Templates** is highlighted, press **Select**.
3. Press **Calls** to highlight the template you want to edit and select **Edit**.
4. Select **Clear** to delete characters and use the keypad to enter your new template text, then select **Save**.

Turn new text message alert on or off

1. Select **Menu**, scroll **Calls** to display **Text messages** and press **Select**.
2. Press **Calls** until **Settings** is highlighted, press **Select**.
3. **Message alert** is highlighted, press **Select**.
4. Press **◀** or **▶** to highlight **On** or **Off** and select **Save**.

You can change any of the 5 pre-populated templates to messages of your choice up to a maximum of 32 characters. If you delete all the characters in a template it will be displayed as 'Empty template' in the template list.

The pre-populated

templates are:

Please call home

I'll be there at

What time will you be home?

I'll call you back

Happy Birthday!

When a text message is received you will hear an audible alert.

The default setting for the text message alert is On but you can turn this off if you want to.

75 Text messaging

Do you have two text phone bases connected to the same phone line?



If you have you are likely to experience problems receiving text messages. Normally, only one SMS/text enabled base unit can be plugged into any line. If you want to keep more than one connected, see page 85.

Service centre numbers

To send and receive text messages you need the telephone number of your network's text centre. If you accidentally delete the send or receive service centre numbers you will need to re-enter them in order for your text service to work. The send and receive centre numbers are pre-populated for BT's PSTN text message service but you can change them to another service if you want to.

BT's text message send service number is: 1470P17094009 and the receive service number is: 0800587529.



Change the service centre numbers

1. Select **Menu**, scroll  to display **Text messages** and press **Select**.
2. Press  until **Settings** is highlighted, press **Select**.
3. Press  until **Service centres** is highlighted, press **Select**. Highlight either **Send centre** or **Receive centre** and select **Edit**.
4. Select **Clear** to delete the digits, then enter the new number and select **Save**.

Using additional handsets

If you've bought a BT6610 multiple pack, any additional handsets come pre-registered to the base. However, if you purchase an additional handset separately, you must register it to your BT6610 base before it can be used.

Register an additional handset

1. Select **Menu**, scroll  to display **Settings** and press **Select**.
2. Press  to highlight **Registration** and press **Select**.
3. **Register** is highlighted, press **Select**.
4. **Press and hold Find button on base** is displayed.
5. Press and hold  on the base until you hear a beep and the In use light starts to flash.
6. Immediately, select **OK** on the handset. The handset will display **Registering handset** to indicate the base is in registration mode. If the system PIN is not 0000 then you will be prompted to enter it, then select **OK**.
7. Once registration is successful the handset will show **Handset x** registered (with X being the assigned handset number). The handset will then synchronise data with any other registered handsets, e.g. contacts, speed dials, handset names and text messages.

You can register up to six GAP compliant handsets to your BT6610 base to extend your phone system without needing to install telephone extension sockets for each new phone.

If a handset becomes un-registered it will need to be registered to the base again. Please register this handset will be displayed, select **OK** then follow the instructions starting from point 4 below.

You have 2 minutes to complete the registration process. After 2 minutes the In use light on the base will stop flashing.





If registration isn't successful the first time, please try again in case the base registration period ran out of time.

If there are already six handsets registered to the base, the registration will fail. You must de-register another handset before you can register the new one.

Registering another make of handset to your BT 6610 base





If you want to register another make of handset (i.e. not a BT6610 handset) to your BT6610 base you will need to follow the Registration instructions that came with the handset first and then continue with the base part of the registration procedure (as shown in point 4 on page 76). Please note that registering other types of handset will only provide limited compatibility i.e. you may only be able to make and receive calls on the additional handset.

De-register a handset

1. Select **Menu**, scroll  to display **Settings** and press **Select**.
2. Press  to highlight **Registration** and press **Select**.
3. Press  to highlight **De-register handset** and press **Select**.
4. Press  or  to highlight the handset you wish to de-register and press **Select**.
5. If the system PIN is not 0000 then you will be prompted to enter it, then select **OK**. If it is 0000, you will continue straight to point 6.
6. The display will show **De-registering handset** and once successful the display will confirm the handset has been de-registered.



Make an internal call between handsets

If you have more than one handset registered to the base, you can make internal calls between two handsets.

1. Press , then press  to scroll through and display the handset you want to call, then press .
2. The receiving handset will ring and your handset name will be presented on the screen. To answer they need to press . If it is not answered after 30 seconds, you will see **Handset not available** on your display.
3. Press  to end the call.

Transfer a call

You can transfer an external call to another handset registered to the base.

1. During a call, select **Options**, then press  to highlight **Transfer call** and press **Select**.
2. If you have one other handset it will ring, if you have more than one other handset you can press  or  to highlight the handset you want, then select **Call** and it will ring. Your external call will be put on hold.

You can also choose All handsets if you want to call all handsets registered to the base. If a handset answers, the handset name will be displayed on your screen.

If an external call is received while an internal call attempt is being made, the internal call will be abandoned and all handsets registered to the base will ring and display the external call information.



You can also choose All handsets if you want to call all handsets registered to the base. If a handset answers, the handset name will be displayed on your screen.

If the internal call is not answered after 30 seconds you will see Handset not available on your display and you will be returned to your external caller.

3. When the other handset answers you can announce the call and then select **Transfer** or press  to transfer the call.

Hold a 3-way call

Using your handset, you can hold a 3-way call with two external callers. Or, you can hold a 3-way call between 2 internal handsets and 1 external caller. Once the 3-way call is in progress other handsets registered to the base can join the call by pressing .

1. During a call, select **Options. Multi call** is highlighted, press **Select**.
2. Either enter the number you want to call or press  and scroll to the number you want or the internal handset you want and then press  to call. When the second call is answered, the first external caller will be put on hold.
3. Select **Join** and all callers will be joined in a 3-way call.

Phone doesn't work

- Have you activated the batteries correctly? See page 5.
- Check that the mains power is correctly connected.

No dial tone or line cord error message displayed on screen

- Is the telephone cord plugged into the base and phone wall socket?
- Check that the mains power is correctly connected.
- Only use the telephone cord supplied with the phone.

Can't make or receive calls

- Check that the mains power is correctly connected.
- The batteries may need recharging.
- Check that product call barring is not active – see Parental control on page 32.
- Has there been a power cut? If so, place the handset back on the base for ten seconds and try again. If it still doesn't work, disconnect the batteries and mains power for ten minutes, then reconnect and try again.

You have a dial tone, but the phone won't dial out

- If you're connected to a switchboard, check whether you need to dial an access code, see page 62.

Handset doesn't ring

- The ringer volume may be switched off, see page 59.
- Check that the mains power is correctly connected.
- Do Not Disturb may be switched on, see page 28.
- Block nuisance calls may be switched on, see page 29.
- Make sure the handset is registered to the base, see page 76.

No display

- The batteries may be flat, dead or incorrectly inserted.
- Recharge or replace the batteries.

Range icon flashes

- Make sure the handset is registered to the base, see page 76.
- Check that the mains power is correctly connected to the base.
- Check that the handset is within range of the base.
- If the batteries are low, place the handset on the base/charger to recharge.

You hear the busy tone when you press

- Make sure the handset is in range of the base.
- Another handset registered to your BT6610 base may be on the line and Auto Join is switched off, please see page 61.

Answering machine doesn't record any messages

- The memory may be full. Play and delete old messages, pages 50-51 and 54-55.

Answering machine messages have the wrong date and time

- Have you set the date and time? See page 65.

Can't access your messages from another phone

- Have you changed the remote access PIN? See page 55-56. Always keep a note of the new PIN in a safe place.
- Has Remote access been turned off? To turn remote access on, see page 56.

No Caller Display number/name displayed

- Have you subscribed to a Caller Display service from your network provider?
See page 40.
- The caller may have withheld their number.
- Network may not have the callers number information.
- An exact name/number match was not found in your contacts. Check that you've stored the full STD dialling code.

Can't register a handset to a base

- You can register up to six handsets to your BT6610 base and your BT6610 handset can only be registered to one base. Check that you've not exceeded the limits.
- Check that you've entered the correct system PIN number (default PIN 0000).
- Check that you're at least one metre away from other electrical equipment to avoid interference when registering.

Base unit does not ring, but the lights are on

- Have you connected the telephone line correctly?
- Do Not Disturb may be switched on, see page 28.
- Block nuisance calls may be switched on, see page 29.
- Is the base ringer set to off?
- You may have a faulty line or socket. Try using another socket or line.
If you are a BT customer then please call 0800 800 151 or your network provider if you still have problems.

Buzzing noise on my phone or on other electrical equipment nearby

- Sometimes other electrical equipment can interfere with your BT6610 if it's placed too close. We recommend that you place your BT6610 at least one metre away from electrical appliances or metal obstructions to avoid any risk of interference.

Customer Helpline

If you're still having problems, call us on **0800 145 6789*** or go to **bt.com/producthelp**

General sales enquiries

- BT Residential lines – call **150**. BT Business lines – call **152**.
- For non BT line customers, call **0800 800 150** (residential) or **0800 800 152** (business).
- Additional handsets available to purchase from the Helpdesk on **0800 145 6789***.

Billing enquiries

Please see the phone number shown on your BT bill.

Possible problems with text messaging

Text messages cannot be sent

- The base station power supply or telephone line cord might not be properly connected.
- Check that the base station power supply is plugged into the mains socket and switched on and that the telephone is plugged into the telephone wall socket.

-
- There might be a fault on the line. Check your telephone line is working properly.
 - You might have deleted the server number in error. See page 75 for instructions on how to enter the number.

Cannot send text

- Check service centre number is correct including 1470P prefix (this is for BT lines. If you have another network provider please check the prefix number with them), see page 75. In order to send and receive text messages you must not withhold your number. If you normally withhold your number the 1470 prefix presents your number for you.

Cannot receive text

- You will not be able to receive text messages until you have first sent a message. The first message sent registers you with the text service.
- More than one text messaging product is plugged into the line. Either remove the other text (SMS) enabled products or see on page 85 “I want to use more than one text (SMS) enabled product on my telephone line” for alternative instructions.
- Check service centre number is correct.
- Ensure you have subscribed to a Caller Display service and that it is active. You can check this by noting if your phone displays your caller’s number when you receive an incoming call.

I want to use more than one text (SMS) enabled product on my telephone line

It is possible to connect more than one SMS product to the same telephone line and for both of them to send and receive Text messages, but you must amend the final digit of both the Send and Receive Service Centre telephone numbers first.

All BT text capable telephones are provided with the same send and receive telephone numbers, but with two or more text capable telephones connected to the same telephone line, delivery of text messages becomes unreliable causing the text to be delivered as a normal telephone call which when answered will be an electronic Text to Speech message.

To overcome this problem you must keep one of the products as it is with the default Send & Receive ending in a '9', but for the second and subsequent products you must change the final digit of the Service Centre numbers (from the default '9') to any unique number between 1 and 8 i.e for a second product change last digit from a '9' to a '1' by changing the Send number from 1470P17094009 to 1470P17094001 and the Receive number from 0800587529 to 0800587521.

For example, for the Send number, go to Menu - Text messages - Settings - Service centres - Send centre - Edit - amend the last digit and then press Save....

Once changed, for the products that you have assigned new send and receive numbers, you need to send a new registration text to the Fixed Line Text Service platform to register the new identity (i.e. send a text to 00000 from the product that you changed the Send & Receive numbers).

You can then send and receive text messages from more than one product.

Text has previously been sent and received but you are now only receiving voice spoken text messages, from number 0845 6021111.

- This may be due to your line being de-registered at the text service centre. Please see page 69 and repeat instructions to register to receive and send text messages.

Further help and advice for text queries on BT lines:

- BT Residential customers – call 151, choose option 2, when prompted by the Fault Management Service select option 2, enter your phone number on the handset and wait to speak to a customer adviser.
- BT Business Customers – call 152, choose option 2, when prompted by the Fault Management Service select option 2, enter your phone number on the handset and wait to speak to a customer adviser.
- For other telephone service providers please contact their customer services.

General information

Important

This equipment is not designed for making emergency phone calls when the power fails. Alternative arrangements should be made for access to emergency services.

This product is intended for connection to analogue public switched telephone networks and private switchboards in the United Kingdom.

Replacing the handset batteries

After a time, you might find that the handset batteries run out of charge more quickly. This is a standard sign of wear and the batteries will need replacing.

1. Open the battery compartment cover.
2. Lift the battery out and remove the batteries.
Replace with two new AAA Ni-MH 750mAh rechargeable batteries.
3. Replace the battery compartment cover.

Caution

Don't immerse batteries in water, throw them into a fire or dispose of them with ordinary domestic refuse. BT accepts no responsibility for damage caused to your BT6610 by using any other types of batteries. There is a risk of explosion if incorrect batteries are fitted.

Safety information

- Only use the power supply suitable for the BT6610. Using an unauthorised power supply will invalidate your guarantee and may damage the phone. The item

code for the base mains power supply is 066270 .

If you've bought a multiple pack, the item code for the charger mains power supply is 066270.

- Use only the approved rechargeable batteries supplied. Spare rechargeable batteries are available from the BT6610 Helpline on 0800 145 6789*.
- Don't open the handset (except to replace the handset batteries) or the base. This could expose you to high voltages or other risks. Contact the Helpline on 0800 145 6789* for all repairs.
- If the keypad is locked, it is still possible to make calls to 999 and 112 emergency numbers by dialling the number then pressing .
- Radio signal transmitted between the handset and base may cause interference to hearing aids.
- It is recommended that advice from a qualified expert be sought before using this product in the vicinity of emergency/intensive care medical equipment.
- It is recommended that if you have a pacemaker fitted you check with a medical expert before using this product.
- Your product may interfere with other electrical equipment, e.g. TV and radio sets, clock/alarms and computers if placed too close.
- It is recommended that you place your product at least one metre away from such appliances to minimise any risk of interference.
- Never dispose of batteries in a fire. There is a serious risk of explosion and/or the release of highly toxic chemicals.

Cleaning

- Clean the handset and base (or charger) with a damp (not wet) cloth, or an anti-static wipe. Never use household polish as this will damage the product. Never use a dry cloth as this may cause a static shock.

Environmental

- Do not expose to direct sunlight.
- The handset may become warm when the batteries are being charged or during prolonged periods of use. This is normal. However, we recommend that to avoid damage you do not place the product on any surface susceptible to heat damage.
- Do not stand your product on carpets or other surfaces which generate fibres, or place it in locations preventing the free flow of air over its surfaces.
- Do not submerge any part of your product in water and do not use it in damp or humid conditions, such as bathrooms.
- Do not expose your product to fire, explosive or other hazardous conditions.
- There is a slight chance your phone could be damaged by an electrical storm. We recommend that you unplug the power and telephone line cord during an electrical storm.

How to recycle your equipment

The symbol shown here and on the product means that the product is classed as electrical or electronic equipment, so DO NOT put it in your normal rubbish bin.



It's all part of the Waste Electrical and Electronic Equipment (WEEE) Directive to recycle products in the best way – to be kinder to the planet, get rid of dangerous things more safely and bury less rubbish in the ground.

You should contact your retailer or supplier for advice on how to dispose of this product in an environmentally friendly way.

Warning

You won't be able to call 999 from this phone if there's a power cut, so make sure you've got another way to call for help in an emergency.

R&TTE Directive & Declaration of Conformity

This product is intended for use within the UK for connection to the public telephone network and compatible switchboards.

This equipment complies with the essential requirements for the Radio Equipment and Telecommunications Terminal Equipment Directive (1999/5/EC).

For a copy of the Declaration of Conformity please refer to bt.com/producthelp

Guarantee

Your BT6610 is guaranteed for 12 months from the date of purchase.

Subject to the terms listed below, the guarantee will provide for the repair of, or at BT's or its agent's discretion, the option to replace the BT6610 or any component thereof, (other than batteries), which is identified as faulty or below standard, or as a result of inferior workmanship or materials. Products over 28 days old from the date of purchase may be replaced with a refurbished or repaired product.

Guarantee conditions

- The guarantee shall only apply to defects that occur within the 12 month guarantee period.
- Proof of purchase is provided.
- The equipment is returned to BT or its agent as instructed.
- This guarantee doesn't cover any faults or defects caused by accidents, misuse, fair wear and tear, neglect, tampering with the equipment, or any attempt at adjustment or repair other than through approved agents.
- This guarantee does not affect your statutory rights.

Within the 12 month guarantee period

Prior to returning your product, please read the Help section beginning on page 80 or contact the BT6610 Helpline on **0800 145 6789***. Additional answers to frequently asked questions are available from **bt.com/producthelp**

In the unlikely event of a defect occurring, the helpdesk will issue a Fault Reference Authorisation (FRA) number and instructions for replacement or repair. Please note you will need the FRA number before returning the product. This does not affect your statutory rights.

Outside of the 12 month guarantee period

If your product needs repair after the guarantee period has ended, the repair must meet the approval requirements for connection to the telephone network. We recommend that you contact BT's recommended repair agent Discount Communications on **0800 980 8999** or a local qualified repairer.

Returning your phone

If the Helpline is unable to remedy your problem they will issue a Fault Reference Authorisation number and ask you to return the product to your original place of purchase. Where possible, pack the product in its original packaging. Please remember to include all parts, including the line cords, power supply units and the original batteries.

Technical information

How many telephones can I have?

All items of telephone equipment have a Ringer Equivalence Number (REN), which is used to calculate the number of items which may be connected to any one telephone line. Your BT6610 has a REN of 1. A total REN of 4 is allowed. If the total REN of 4 is exceeded, the telephones may not ring. With different telephone types there is no guarantee of ringing, even when the REN is less than 4.

Any additional handsets and chargers that you register have a REN of 0.

Connecting to a switchboard

Switchboard compatibility

This telephone may be connected to most types of switchboard, however in the event of any difficulties, consult your switchboard Service Provider.

Recall (R)

Recall is used when connected to certain switchboards/PBXs and some BT Calling Features, or those services available via your network provider. The BT6610 supports time break recall but not earth loop recall.

R&TTE

This product is intended for use within the UK for connection to the public telephone network and compatible switchboards.

This equipment complies with the essential requirements for the Radio Equipment and Telecommunications Terminal Equipment Directive (1999/5/EC).

Declaration of Conformance

Hereby, BT declares that this BT6610 is in compliance with the essential requirements and other relevant provisions of Directive 1999/5/EC.

If you would like a copy of the Declaration of Conformance, please visit bt.com/producthelp

For your records

Date of purchase:

Place of purchase:

For guarantee purposes, proof of purchase is required, so please keep your receipt.

Enter your base system PIN here:

[/ / /]

Enter your remote access PIN here:

[/ / /]

For a Better Future 

We're always looking to make our products last longer and use less power, so we don't have such a big impact on the environment.

To find out about what we are doing, visit
bt.com/betterfuture

Offices worldwide

The services described in this publication are subject to availability and may be modified from time to time. Services and equipment are provided subject to British Telecommunications plc's respective standard conditions of contract. Nothing in this publication forms any part of any contract.

© British Telecommunications plc 2015.
Registered Office: 81 Newgate Street, London EC1A 7AJ.
Registered in England No. 1800000.
Printed in China.

Designed by The Art & Design Partnership.

Available in other formats including braille, large print or audio CD.
If you would like a copy, please call 0800 145 6789*.

* Calls made from within the UK mainland network are free.
Mobile and international call costs may vary.

BT6610 (12/15) Issue 1

